

ESTAMP

FURNITURE FITTINGS MÖBELBESCHLÄGE

HERBAJES PARA MUEBLES GARNITURES POUR MEUBLES



J. JOSÉ VERGÉS S.A.
1928



4-7	Presentación Présentation Presentation Beschreibung
8-71	Metal Metal Metal Metall
72-81	Acero Inoxidable Acier Inox Stainless Steel Rostfreier Stahl
82-89	Resinas Résines Resins Harze
90-99	Madera Bois Wood Holz
100-107	Porcelana Porcelaine Porcelain Porzellan
108-113	Cristal Cristal Crystal Kristall
114-127	Complementos Complements Complements Ergänzungen
128-133	DecorClass
134-135	Índice de referencias Index de références Index of references Index der Referenzen

80 años en constante evolución

Mucho tiempo en lo que todo ha cambiado. También en **J. José Vergés**, salvo su espíritu de superación, crecimiento y expansión. Una búsqueda continua de la excelencia en la creación de herrajes, pequeñas obras de arte para sus muebles.

80 ans en constante évolution

*Pendant ce temps beaucoup de choses ont changées. Chez **J. José Vergés** aussi sauf son esprit d'amélioration, croissance et développement. Une recherche continue de l'excellence dans la création de garnitures, petites oeuvres d'art pour vos meubles.*

80 years in constant evolution

A long time during which everything has changed. Also at **J. José Vergés**, excepting for its eagerness to do better, to grow and to expand. A continuous search of the excellence in the creation of fittings, small masterpieces for your furniture.

80 Jahre konstanter Evolution

*Eine lange Zeit, in der sich viel verändert hat. In **J. José Vergés** erhielten wir über diesen Zeitraum den Geist der Überwindung, des Wachstums und der Expansion aufrecht. Eine andauernde Suche nach vorzüglicher Kreation von Beschlägen, kleinen Kunstwerken für Ihre Möbel.*



Una empresa, **J. José Vergés**, y una marca, **Estamp**, liderando desde 1928 y en 80 países en innovación, calidad y servicio para convertir sus pomos y tiradores en un referente obligado del diseño más actual.

*Une entreprise, **J. José Vergés**, et une marque **Estamp**, qui est en tête depuis 1928 et dans 80 pays en innovation, qualité et service pour transformer ses boutons et poignées en une référence obligée du design le plus actuel.*

A company, **J. José Vergés**, and a brand, **Estamp**, leading since 1928 and in 80 countries in innovation, quality and service turning their knobs and handles into an obliged reference of the most up to date design.

*Unter Unternehmen, **J. José Vergés**, und der Markenname **Estamp**, sind führend seit 1928 in 80 Ländern auf den Gebieten Innovation, Qualität und Kundendienst. Unsere Griffe und Knöpfe sind ein obligater Bezugspunkt des modernen Designs.*



Al servicio de las últimas tendencias en decoración.

Au service des dernières tendances en décoration.



J. José Vergés, en cualquier lugar del mundo y siempre cerca de sus clientes.

J. José Vergés, dans tout le monde et toujours près de ses clients.

At the service of the latest trends in decoration.

Im Dienste der aktuellsten Dekorationstrends.

J. José Vergés, throughout the world and always near their customers.

J. José Vergés, weltweit in der Nähe seiner Kunden.

1928



1950



1965



1989



2003



ESTAMP

PRESENTACIÓN / PRÉSENTATION
PRESENTATION / BILDSCHRIFTUNG

003

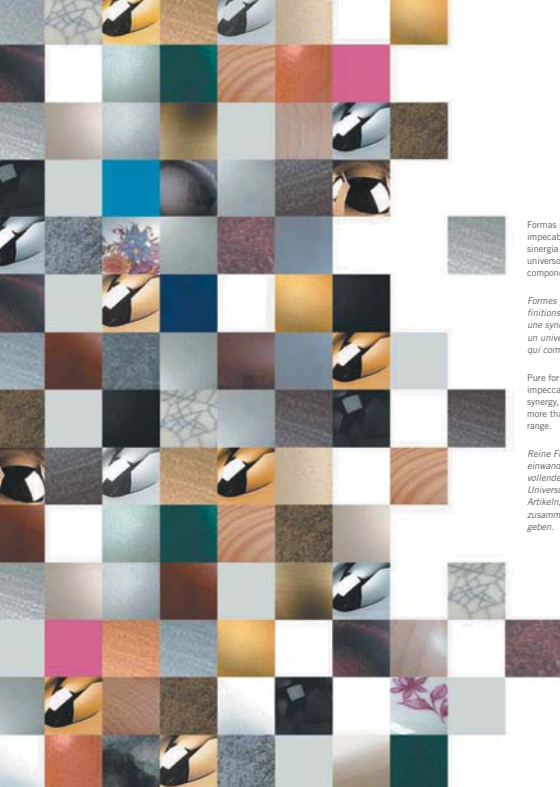

Formas puras, elegantes colores e impecables acabados, se unen en una sinergia perfecta para dar vida a un universo de más de 1.500 artículos que componen nuestra gama.

Formes pures, couleurs élégantes et finitions impeccables, se joignent en une synergie parfaite pour donner vie à un univers de plus de 1.500 références qui composent notre gamme.

Pure forms, elegant colours and impeccable finishes, united in a perfect synergy, to bring alive a universe with more than 1500 items in our complete range.

Reine Formen, elegante Farben und einwandfreies Finish münden in einer vollendeten Synergie, um dem Universum von weit mehr als 1500 Artikeln, die unsere Angebotspalette zusammensetzen, ein eigenes Leben zu geben.





Tecnología con alma

En **J. José Vergés** utilizamos la más alta tecnología para crear piezas de acabado perfecto y calidad garantizada, pero su esencia, lo que deben transmitir y hacernos sentir, lo dejamos en manos de la experiencia, el ingenio y la imaginación de nuestros diseñadores.

Une Technologie avec une âme

*Chez **J. Jose Vergés** nous utilisons la plus haute technologie pour créer des pièces de finitions parfaites et une qualité garantie, mais son essence, celle qui doit nous être transmise et que l'on doit ressentir, on la laisse aux mains de l'expérience, de l'esprit et de l'imagination de nos designers.*

Technology with soul

At **J. José Vergés** we use the highest technology to create pieces with a perfect finish and guaranteed quality, but the essence, what they must convey and make us feel, we leave it in the hands of experience, to the wit and imagination of our designers.

Technologie mit Herz

*In **J. José Vergés** verwenden wir die fortgeschrittenste Technologie, um ein perfektes Finish und garantierte Qualität herzustellen. Das Wesentliche, was wir vermitteln wollen, überlassen wir gleichwohl der Erfahrung, Vorstellungskraft und Erfindungsgabe unserer Designer.*

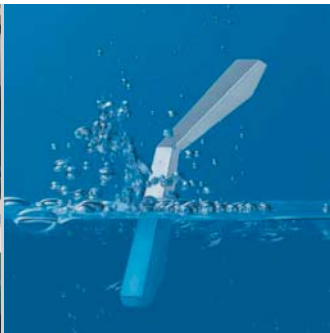

ESTAMP

PRESENTACIÓN / PRESENTATION
PRESENTATION / BILDSCHRIFTUNG

07 18



METAL / METAL / METALL



METAL / METAL

Knob How
BY ESTAMP

ARTTECH
COLLECTION

NEWRUSTIC
COLLECTION

COUNTRY
COLLECTION



EDGE

Knob
BY ESTAMP
How



ZAMAK
METAL
METAL
METAL

	Lmm	Φmm	Hmm	Ømm	mm
7531	188	180	9	35	
7532	124	96	8	30	



021
Aluminio
Aluminium
Aluminium
Aluminium



038
Níquel cepillado
Nickelé brossé
Brushed nickel
Gebürstetes Nickel



400
Cromo brillo
Chromé brillant
Bright chrome
Glänzend verchromt



800
Cromo mate
Chromé mat
Dull chrome
Matt verchromt



JAZZ



ZAMAK
METAL
METAL
METALL

	mm	mm	mm	mm	mm
7751	204	160	25	29	
7752	124	96	25	29	



021
Aluminio
Aluminium
Aluminium
Aluminium



038
Níquel cepillado
Nickelé brossé
Brushed nickel
Gebürstetes Nickel



400
Cromo brillo
Chromé brillant
Bright chrome
Glänzend verchromt



800
Cromo mate
Chromé mat
Dull chrome
Matt verchromt



Knob How

BY STAMP



I-SPAZIO



ZAMAK
METAL
METAL
METALL

	mm	mm	mm	A	B	C	mm
7570	260	192	8	22	108	130	32
7571	260	192	8	76	108	76	32
7572	200	128	8	56	68	56	32



021
Aluminio
Aluminium
Aluminium
Aluminium



032
Negro mate
Noir mat
Dull black
Mattschwarz



038
Niquel capillado
Nickel brossé
Brushed nickel
Gebürstetes Nickel



292
Bianco mate
Blanc mat
Dull white
Matt Weiß



400
Cromo brillo
Chromé brillant
Bright chrome
Glänzend verchromt



800
Cromo mate
Chromé mat
Dull chrome
Matt verchromt









vista posterior
face arrière
rear face
Rückansicht

Knob How

BY ESTAMP

SEIZE



	mm	mm	mm	mm	mm
	180	180	50	16	
	021		038		400
Aluminio Aluminium Aluminium	Niquel cepillado Nickelé brossé Brushed nickel Gebürstetes Nickel	Cromo brillo Chromé brillant Bright chrome Glänzend verchromt	Cromo mate Chromé mat Dull chrome Matt verchromt		
	180	170	25	16	
	021				
Aluminio Aluminium Aluminium					

METAL / METAL / METAL / METAL

Knob How



SCENE



	3710	80x80	76	14
mm	Ømm	mm	mm	mm

ZAMAK
METAL
METAL
METAL

101



038

Níquel cepillado
Nickelé brossé
Brushed nickel
Gebürstetes Nickel



100

Dorado brillo
Doré brillant
Gold plated
Glänzend vergoldet



400

Cromo brillo
Chromé brillant
Bright chrome
Glänzend verchromt



800

Cromo mate
Chromé mat
Dull chrome
Matt verchromt



Knob How

BY ESTAMP

SHIELD



	Ømm4	Ømm	Ømm	Ømm
3580		80	60	11
3581		60	45	11
3582		46	35	11
3583		34	26	11

ZAMAK
METAL
METAL
METAL



038
Niquel cepillado
Nickel brossé
Brushed nickel
Gebürstetes Nickel



100
Dorado brillo
Doré brillant
Gold plated
Glänzend vergoldet



400
Cromo brillo
Chromé brillant
Bright chrome
Glänzend verchromt



800
Cromo mate
Chromé mat
Dull chrome
Matt verchromt

METAL / METAL / METAL / METAL

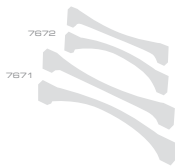

COMPASS



ZAMAK
METAL
METAL
METAL

Wmm x Φmm x Hmm Ømm Zmm

7671	175	160	9	26
7672	141	128	8	24



038
Niquel cepillado
Nickelé brossé
Brushed nickel
Gebürstetes Nickel



400
Cromo brillo
Chromé brillant
Bright chrome
Glänzend verchromt



800
Cromo mate
Chromé mat
Dull chrome
Matt verchromt





ARTTECH
COLLECTION

STRIFE



mmmm ϕ mmmm \times mmmm ϕ mm $\frac{1}{2}$ mm

ZAMAK
METAL
METAL
METAL

7681	238	192	25	27
7682	195	160	24	27
7683	153	128	23	27
7684	120	96	22	27



021
Aluminio
Aluminum
Aluminium
Aluminum



038
Niquel cepillado
Nickelè brossé
Brushed nickel
Gebürstetes Nickel



400
Cromo brillo
Chromè brillant
Bright chrome
Glänzend verchromt



800
Cromo mate
Chromè mat
Dull chrome
Matt verchromt



METAL / METAL / METAL / METAL



7739
7738
7737
7736
7735
7734
7733
7732
7731
7730

7741
7740

PURE



	Lmm	φmm	Hmm	Bmm	Imm
7730	848	832	16		37
7731	688	672	16		37
7732	656	640	16		37
7733	464	448	16		37
7734	400	384	16		37
7735	304	288	16		37
7736	240	224	16		37
7737	208	192	16		37
7738	176	160	16		37
7739	144	128	16		37
7740	1068	1050	16		37
7741	912	896	16		37

ZAMAK
METAL
METAL



021
Aluminio
Aluminium
Aluminium
Aluminium



036
Niquel cepillado
Nickelé brossé
Brushed nickel
Gebürstetes Nickel



400
Cromo brillo
Chromé brillant
Bright chrome
Glänzend verchromt



800
Cromo mate
Chromé mat
Dull chrome
Matt verchromt





7691

7692

7693

7694

DUAL



ZAMAK
METAL
METAL
METALL

mm x mm x mm x mm x mm

7691	201	192	10	26
7692	169	160	10	26
7693	137	128	10	26
7694	26	16	10	26



021

Aluminio
Aluminium
Aluminium
Aluminium



038

Niquel cepillado
Nickel brossé
Brushed nickel
Gebürstetes Nickel



400

Cromo brillo
Chromé brillant
Bright chrome
Glänzend verchromt



800

Cromo mate
Chromé mat
Dull chrome
Matt verchromt



METAL / METAL / METAL / METALL



ARTTECH
COLLECTION

SMOOTH



ZAMAK
METAL
METAL
METALL

	mm	mm	mm	mm	mm
7651	232	224	30	28	
7652	200	192	30	28	
7653	168	160	30	28	



038

Níquel cepillado
Nickel brossé
Brushed nickel
Gebürstetes Nickel



400

Cromo brillo
Chromé brillant
Bright chrome
Glänzend verchromt



800

Cromo mate
Chromé mat
Dull chrome
Matt verchromt

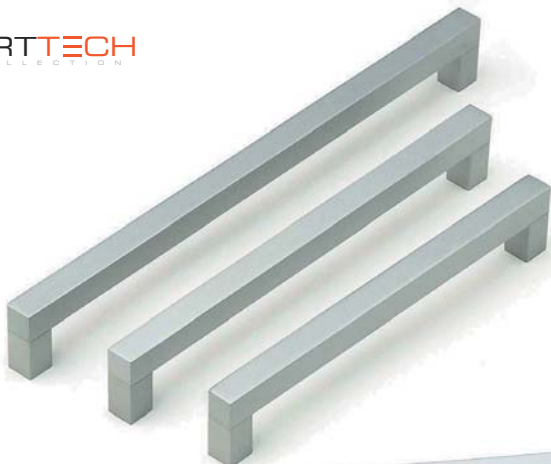

7520
7521
7020
7021
7022
7023
7024
7025
7026

ALLUSTYLE



mmmm mmmm mmmm mmmm mmmm

	mm	mm	mm	mm
7020	462	448	14	35
7021	398	384	14	35
7022	302	288	14	35
7023	238	224	14	35
7024	206	192	14	35
7025	174	160	14	35
7026	142	128	14	35
7520	846	832	14	35
7521	654	640	14	35

ALUMINIO
ALUMINIUM
ALUMINIUM
ALUMINIUM

Ø18

Aluminio anodizado
Aluminium anodisè
Anodized aluminium
Aluminium eloxiert

METAL / METAL / METAL / METAL

ARTTECH
COLLECTION



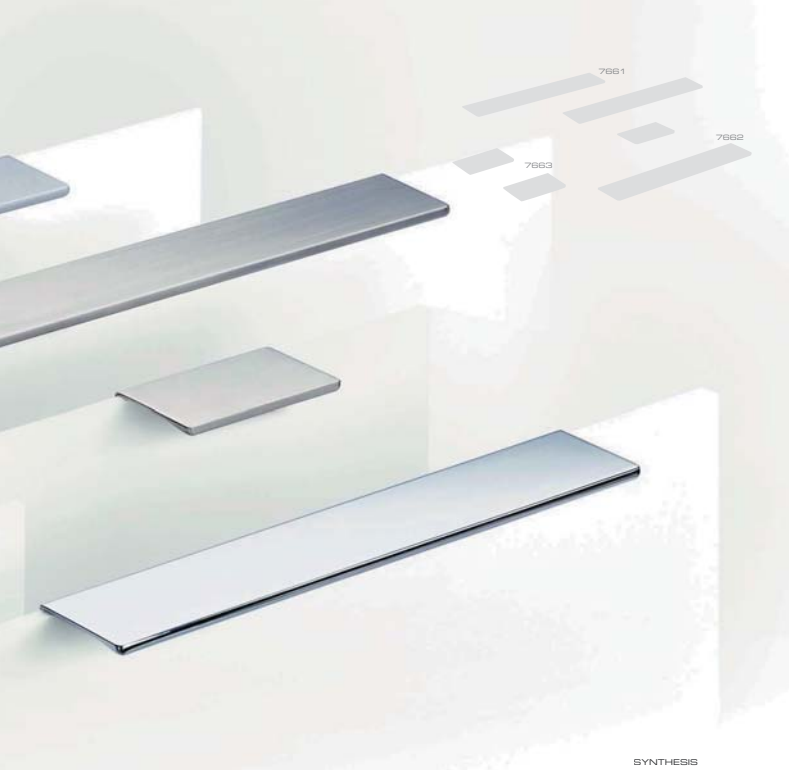

SYNTHESIS



ZAMAK
METAL
METAL

mm x mm x mm mm mm mm

7661	231	192	44	24
7662	135	96	44	24
7663	71	32	44	24



021
Aluminio
Aluminium
Aluminium



038
Niquel cepillado
Nickelé brossé
Brushed nickel
Gebürstetes Nickel



400
Cromo brillo
Chromé brillant
Bright chrome
Glänzend verchromt



800
Cromo mate
Chromé mat
Dull chrome
Matt verchromt

METAL / METAL / METAL / METAL



ALIGN



ZAMAK
METAL
METAL
METALL

7541	252	224	9	
7542	220	192	9	
7543	157	128	9	
B130				15x15



021
Aluminio
Aluminium
Aluminium
Aluminium



038
Níquel cepillado
Nickelé brossé
Brushed nickel
Gebürstetes Nickel



400
Cromo brillo
Chromé brillant
Bright chrome
Glänzend verchromt



800
Cromo mate
Chromé mat
Dull chrome
Matt verchromt

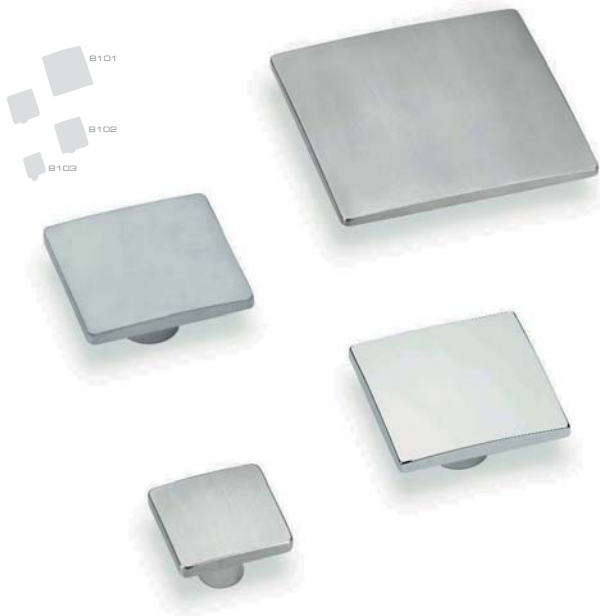

ARTTECH
COLLECTION

WAVE



	ZAMAK	METAL	METAL	METAL
	mm4	mm	mm	mm
B101	80	80		
B102	50	50		
B103	32	32		



021
Aluminio
Aluminium
Aluminium
Aluminium



038
Niquel cepillado
Nickelé brossé
Brushed nickel
Gebürstetes Nickel



400
Cromo brillo
Chromé brillant
Bright chrome
Glänzend verchromt



800
Cromo mate
Chromé mat
Dull chrome
Matt verchromt

METAL / METAL / METAL / METAL



CUBIC

	W4	H	L	Ø	S
	mm	mm	mm	mm	mm
7481	115	96	12		
7482	85	64	11		
7483	55	32	10		

ZAMAK
METAL
METAL
METALL



021
Aluminio
Aluminium
Aluminium
Aluminium



038
Niquel cepillado
Nickel brossé
Brushed nickel
Gebürstetes Nickel



400
Cromo brillo
Chromé brillant
Bright chrome
Glänzend verchromt



800
Cromo mate
Chromé mat
Dull chrome
Matt verchromt





ARTTECH
COLLECTION

SQUARE



ZAMAK
METAL
METAL
METALL

Wmm4 φmm4 Hmmmm Ømm mm

7471	148	128	12
7472	114	96	11
7473	81	64	10
8090			12x12



021
Aluminio
Aluminium
Aluminium



038
Niquel cepillado
Nickelé brossé
Brushed nickel
Gebürstetes Nickel



400
Cromo brillo
Chromé brillant
Bright chrome
Glänzend verchromt



800
Cromo mate
Chromé mat
Dull chrome
Matt verchromt



METAL / METAL / METAL / METALL

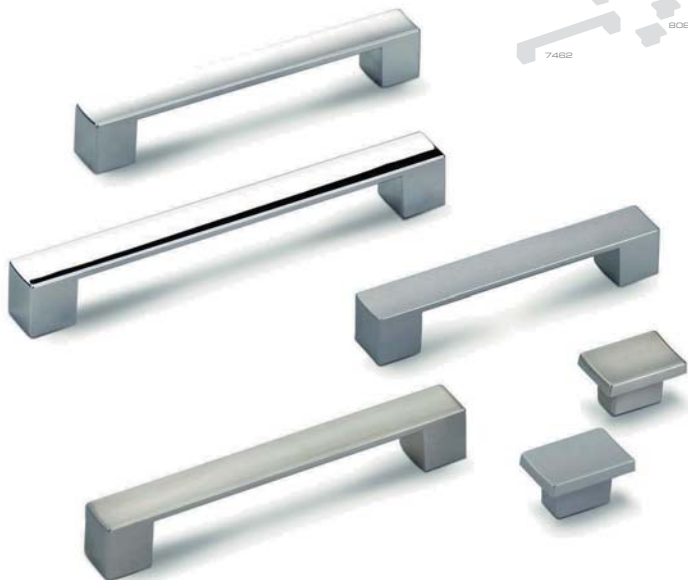
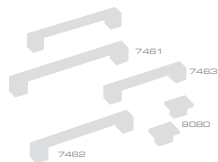

BLOCK



ZAMAK
METAL
METAL
METALL

mm mm mm mm mm mm

7461	197	180	21		
7462	161	128	19		
7463	129	96	18		
8080		16		37x25	



021
Aluminio
Aluminium
Aluminium
Aluminium



038
Niquel cepillado
Nickelé brossé
Brushed nickel
Gebürstetes Nickel



400
Cromo brillo
Chromé brillant
Bright chrome
Glänzend verchromt



800
Cromo mate
Chromé mat
Dull chrome
Matt verchromt





ZAMAK
METAL
METAL
METALL

mmmm ϕ mm ϕ mm ϕ mm ϕ mm

7381	200	128	19	
7382	160	96	17	
8851				50x35
8852				35x24



021
Aluminio
Aluminium
Aluminium
Aluminium



038
Níquel cepillado
Nickel brossé
Brushed nickel
Gebürstetes Nickel



400
Cromo brillo
Chromé brillant
Bright chrome
Glänzend verchromt



800
Cromo mate
Chromé mat
Dull chrome
Matt verchromt



ZAMAK
METAL
METAL
METAL

	L mm	H mm	Ø mm
7241	200	192	20
7242	168	160	20



021
Aluminio
Aluminium
Aluminium
Aluminium



038
Níquel cepillado
Nickelè brossé
Brushed nickel
Gebürstetes Nickel



400
Cromo brillo
Chromè brillant
Bright chrome
Glänzend verchromt



800
Cromo mate
Chromè mat
Dull chrome
Matt verchromt



ZAMMAK
METAL
METAL
METALL

	L-mm	W-mm	H-mm	Ø-mm	Ø2-mm
7251	149	128	20		
7252	117	98	18		
8780					20x20



021
Aluminio
Aluminium
Aluminium



038
Níquel cepillado
Nickelé brossé
Brushed nickel
Gebürstetes Nickel



100
Dorado brillo
Doré brillant
Gold plated
Glänzend vergoldet



805
Latón cepillado rústico
Laiton brossé rustique
Rustic brushed brass
Messing rustikal, gebürstet



831
Bronce rústico
Bronze rustique
Antique brass
Bronze rustikal



836
Estaño rústico
Etain rustique
Rustic tin
Zinn rustikal



	192	180	22
7411	192	180	22
7412	153	128	21

ZAMAK
METAL
METAL
METALL

021
Aluminio
Aluminium
Aluminium
Aluminium

038
Niquel cepillado
Nickelê brôssê
Brushed nickel
Gebürstetes Nickel

400
Cromo brillo
Chromê brillant
Bright chrome
Glänzend verchromt

800
Cromo mate
Chromê mat
Dull chrome
Matt verchromt



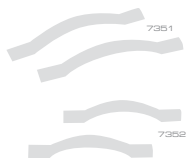

mm ϕ mm \times mm ϕ mm ϕ mm

7351	221	128	25
7352	181	98	23

ZAMAK
METAL
METAL
METALL



021
Aluminio
Aluminium
Aluminium



038
Niquel cepillado
Nickelé brossé
Brushed nickel
Gebürstetes Nickel



400
Cromo brillo
Chromé brillant
Bright chrome
Glänzend verchromt



800
Cromo mate
Chromé mat
Dull chrome
Matt verchromt



METAL / METAL / METAL / METALL



				
7300				
7300	180	64	23	ZAMAK METAL METAL METALL

021
 Aluminio
 Aluminium
 Aluminium
 Aluminium

038
 Niquel cepillado
 Nickelé brossé
 Brushed nickel
 Gebürstetes Nickel

400
 Cromo brillo
 Chromé brillant
 Bright chrome
 Glänzend verchromt



ZAMAK
METAL
METAL
METAL

mm4 ϕ mm4 H|mm \varnothing mm S-mm

7311 178 160 33

7312 144 128 32



038
Niquel cepillado
Nickel brossé
Brushed nickel
Gebürstetes Nickel



400
Cromo brillo
Chromé brillant
Bright chrome
Glänzend verchromt



800
Cromo mate
Chromé mat
Dull chrome
Matt verchromt



METAL / METAL / METAL / METAL



ZIRAK
METAL
METAL
METALL

mm mm mm mm mm

7161	128	96	16
7162	48	32	16



021
Aluminio
Aluminium
Aluminium
Aluminum



038
Niquel cepillado
Nickelé brossé
Brushed nickel
Gebürstetes Nickel



100
Dorado brillo
Doré brillant
Gold plated
Glänzend vergoldet



400
Cromo brillo
Chromé brillant
Bright chrome
Glänzend verchromt



500
Niquel satinado
Nickelé satiné
Satin nickel
Sattiniertes Nickel



	W mm	H mm	L mm	Ø mm	Ø mm
7321	208	192	24		
7322	176	160	24		
8800				30	22

ZAMAK
METAL
METAL
METAL



021
Aluminio
Aluminium
Aluminium
Aluminium



038
Níquel cepillado
Nickelè brossé
Brushed nickel
Gebürstetes Nickel



400
Cromo brillo
Chromè brillant
Bright chrome
Glänzend verchromt



800
Cromo mate
Chromè mat
Dull chrome
Matt verchromt





ZAMAK
METAL
METAL
METAL

7291	81	64	12
7292	48	32	12



021
Aluminio
Aluminium
Aluminium
Aluminium



038
Níquel cepillado
Nickelé brossé
Brushed nickel
Gebürstetes Nickel



400
Cromo brillo
Chromé brillant
Bright chrome
Glänzend verchromt



500
Níquel satinado
Nickelé satiné
Satin nickel
Satinisiertes Nickel



800
Cromo mate
Chromé mat
Dull chrome
Matt verchromt

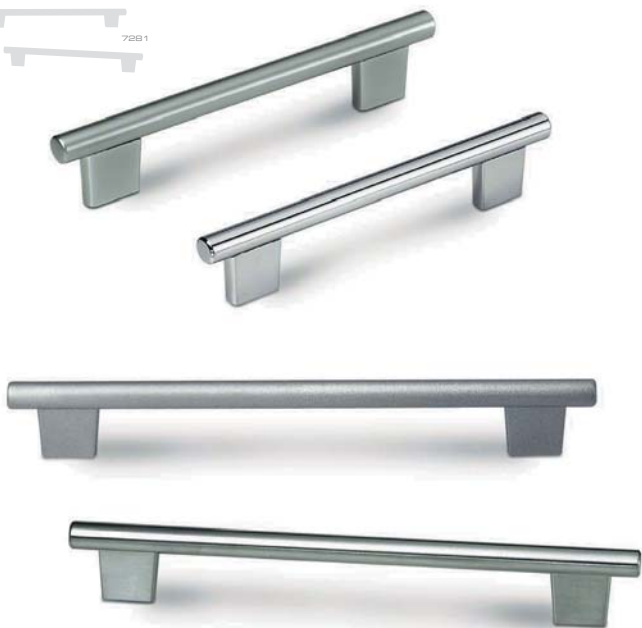

ZANAK
METAL
METAL
METALL

7281	242	192	12
7282	178	128	12



021
Aluminio
Aluminium
Aluminium
Aluminium



038
Níquel cepillado
Nickelé brossé
Brushed nickel
Gebürstetes Nickel



400
Cromo brillo
Chromé brillant
Bright chrome
Glänzend verchromt



800
Cromo mate
Chromé mat
Dull chrome
Matt verchromt



mmmm ϕ mm \times mm ϕ mm \times mm

7131	165	128	20
7132	130	96	16
7140	53	32	19

ZAMAK
METAL
METAL
METALL



021
Aluminio
Aluminium
Aluminium



032
Negro mate
Noir mat
Mattschwarz



038
Niquel cepillado
Nickel brossé
Brushed nickel
Gebürstetes Nickel



100
Dorado brillo
Doré brillant
Gold plated
Glänzend vergoldet



400
Cromo brillo
Chromé brillant
Bright chrome
Glänzend verchromt



500
Niquel satinado
Nickel satiné
Satin nickel
Satiniertes Nickel



800
Cromo mate
Chromé mat
Dull chrome
Matt verchromt





B701	35
B702	30



B711	37x30
B712	32x26



002
Blanco
Blanc
White
Weiß



030
Bronce cepillado
Bronze brossé
Brushed bronze
Gebürstetes bronziert



038
Níquel cepillado
Nickel brossé
Brushed nickel
Gebürstetes Nickel



100
Dorado brillo
Doré brillant
Gold plated
Glänzend vergoldet



052
Negro mate
Noir mat
Dull black
Mattschwarz



038
Níquel cepillado
Nickel brossé
Brushed nickel
Gebürstetes Nickel



100
Dorado brillo
Doré brillant
Gold plated
Glänzend vergoldet



400
Cromo brillo
Chromé brillant
Bright chrome
Glänzend verchromt



800
Cromo mate
Chromé mat
Dull chrome
Matt verchromt



831
Bronce rústico
Bronze rustique
Antique brass
Bronze rustikal



836
Estaño rústico
Étain rustique
Rustic tin
Zinn rustikal



400
Cromo brillo
Chromé brillant
Bright chrome
Glänzend verchromt



800
Cromo mate
Chromé mat
Dull chrome
Matt verchromt



ZAMAK
METAL
METAL
METALL

	L mm	W mm	H mm	Ø mm	S mm
7121	163	128	23		
7122	129	96	20		
8731				35	
8732				30	



032
Negro mate
Noir mat
Dull black
Mattschwarz



038
Niquel cepillado
Nickelé brossé
Brushed nickel
Gebürstetes Nickel



100
Dorado brillo
Doré brillant
Gold plated
Glänzend vergoldet



500
Niquel satinado
Nickelé satiné
Satin nickel
Satinirtes Nickel



ZAMAK
METAL
METAL
METALL

mm L mm H mm Ø mm S mm

70B1	142	128	15	
70B2	107	96	13	



ZAMAK
METAL
METAL
METALL

mm L mm H mm Ø mm S mm

7051	148	128	16	
7052	112	96	13	



038

Nichel cepillado
Nickelé brossé
Brushed nickel
Gebürstetes Nickel



100

Dorado brillo
Doré brillant
Gold plated
Glänzend vergoldet



500

Nichel satinado
Nickelé satiné
Satin nickel
Satinertes Nickel



038

Nichel cepillado
Nickelé brossé
Brushed nickel
Gebürstetes Nickel



100

Dorado brillo
Doré brillant
Gold plated
Glänzend vergoldet



400

Cromo brillo
Chromé brillant
Bright chrome
Glänzend verchromt



800

Cromo mate
Chromé mat
Dull chrome
Matt verchromt

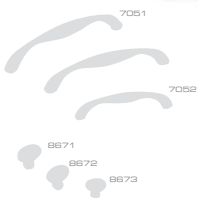

ZAMAK
METAL
METAL
METALL

mm4 φmm Hmm Ømm Smm

8871	34x22
8872	31x20
8873	25x17



002
Blanco
Blanc
White
Weiß



032
Negro mate
Noir mat
Dull black
Mattschwarz



038
Níquel cepillado
Nickelé brossé
Brushed nickel
Gebürstetes Nickel



100
Dorado brillo
Doré brillant
Gold plated
Glänzend vergoldet



400
Cromo brillo
Chromé brillant
Bright chrome
Glänzend verchromt



800
Cromo mate
Chromé mat
Dull chrome
Matt verchromt



805
Latón cepillado rústico
Laiton brossé rustique
Rustic brushed brass
Messing rustikal, bürstet



807
Hierro rústico
Fer rustique
Rustic iron
Eisen rustikal



METAL / METAL / METAL / METALL



ZAMAK
METAL
METAL
METALL



7031	160	128	14
7032	126	96	13



090

Bronce cepillado
Bronze brossé
Gebürstet bronziert



098

Níquel cepillado
Nickelé brossé
Gebürstetes Nickel



100

Dorado brillo
Doré brillant
Glänzend vergoldet



400

Cromo brillo
Chromé brillant
Glänzend verchromt



800

Cromo mate
Chromé mat
Matt verchromt



807

Hierro rústico
Fer rustique
Rustic iron
Eisen rustikal



831

Bronce rústico
Bronze rustique
Antique brass
Bronze rustikal



836

Estaño rústico
Etain rustique
Rustic tin
Zinn rustikal



7930

ZAMAK
METAL
METAL
METALL

mm ϕ mm ϕ mm ϕ mm ϕ mm

7930 137 98 14



002
Blanco
White
Weiß



038
Niquel cepillado
Nickelè brossé
Brushed nickel
Gebürstetes Nickel



100
Dorado brillo
Doré brillant
Gold plated
Glänzend vergoldet



400
Cromo brillo
Chromè brillant
Bright chrome
Glänzend verchromt



800
Cromo mate
Chromè mat
Dull chrome
Matt verchromt



METAL / METAL / METAL / METALL



ZAMAK
METAL
METAL
METALL

130mm x 96mm x 11mm 10mm x 84mm

	130	96	11
7061			
7062	98	84	10
8691			18
8692			12



032
Negro mate
Noir mat
Dull black
Mattschwarz



038
Niquel cepillado
Nickelè brossé
Brushed nickel
Gebürstetes Nickel



100
Dorado brillo
Doré brillant
Gold plated
Glänzend vergoldet



800
Cromo mate
Chromé mat
Dull chrome
Matt verchromt



7553



7552



7554



ZAMAK
METAL
METAL
METALL

W mm Ø mm H mm Ø mm S mm

7552	108	96	10		
7553	80	70	9		
7554	42	32	9		



002
Blanco
Blanc
White
Weiß



033
Negro brillo
Noir brillant
Bright black
Glänzend schwarz



100
Dorado brillo
Doré brillant
Gold plated
Glänzend vergoldet



400
Cromo brillo
Chromé brillant
Bright chrome
Glänzend verchromt



ZAMAK
METAL
METAL
METALL

	L	H	Ø
7861	164	128	10
7862	124	96	9



002
Bianco
Blanc
White
Weiß



021
Aluminio
Aluminium
Aluminium



031
Inoxidable cepillado
Inox brossé
Brushed stainless
Rostfreier Stahl, gebürstet



033
Negro brillo
Noir brillant
Bright black
Glänzend schwarz



038
Niquel cepillado
Nickelé brossé
Brushed nickel
Gebürstetes Nickel



100
Dorado brillo
Doré brillant
Gold plated
Glänzend vergoldet



400
Cromo brillo
Chromé brillant
Bright chrome
Glänzend verchromt



600
Niquel satinado
Nickelé satiné
Satin nickel
Satiniertes Nickel



700
Niquel negro
Nickelé noir
Black nickel
Schwarz verrnickelt



800
Cromo mate
Chromé mat
Dull chrome
Matt verchromt



8830



ZAMAK
METAL
METAL
METALL

mm ϕ mm \times mm ϕ mm \times mm

8830

30x19



021
Aluminio
Aluminium
Aluminium
Aluminium



038
Níquel cepillado
Nickelé brossé
Brushed nickel
Gebürstetes Nickel



100
Dorado brillo
Doré brillant
Gold plated
Glänzend vergoldet



400
Cromo brillo
Chromé brillant
Bright chrome
Glänzend verchromt



800
Cromo mate
Chromé mat
Dull chrome
Matt verchromt

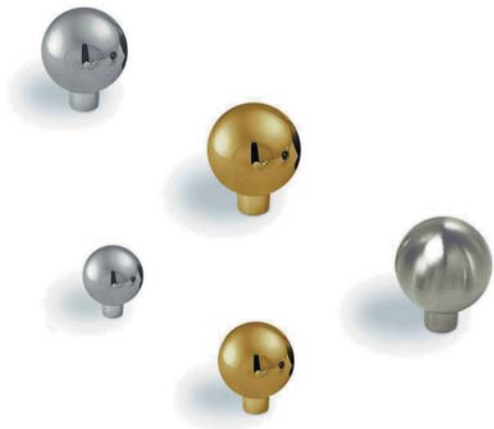

ZAMAK
METAL
METAL
METALL

Model	Height (mm)
B321	33
B322	28
B323	24
B324	18



038
Niquel cepillado
Nickel brossé
Brushed nickel
Gebürstetes Nickel



100
Dorado brillo
Doré brillant
Gold plated
Glänzend vergoldet



400
Cromo brillo
Chromé brillant
Bright chrome
Glänzend verchromt



800
Cromo mate
Chromé mat
Dull chrome
Matt verchromt



LATÓN
LATON
SPRAGS
MESSING

mm ϕ mm ϕ mm ϕ mm ϕ mm

BB10	16
BB20	16



021
Aluminio
Aluminium
Aluminium
Aluminium



038
Níquel cepillado
Nickel brossé
Brushed nickel
Gebürstetes Nickel



100
Dorado brillo
Doré brillant
Gold plated
Glänzend vergoldet



400
Cromo brillo
Chromé brillant
Bright chrome
Glänzend verchromt



METAL / METAL / METAL / METAL



ZAMAK
METAL
METAL
METALL

mm ϕ mm \pm mm \pm mm \pm mm

8010

12

ZAMAK
METAL
METAL
METALL

mm ϕ mm \pm mm \pm mm \pm mm

8790

20



002
Blanco
Blanc
White
Weiß



021
Aluminio
Aluminium
Aluminium



033
Negro brillo
Noir brillant
Bright black
Glänzend schwarz



021
Aluminio
Aluminium
Aluminium



038
Níquel cepillado
Nickel brossé
Brushed nickel
Gebürstetes Nickel



400
Cromo brillo
Chromé brillant
Bright chrome
Glänzend verchromt



100
Dorado brillo
Doré brillant
Gold plated
Glänzend vergoldet



400
Cromo brillo
Chromé brillant
Bright chrome
Glänzend verchromt



7830



Wmm4 φmm4 Hmm Ømm -S-mm

7830

110

96

11

ZAMAK
METAL
METAL
METALL



100

Dorado brillo
Doré brillant
Gold plated
Glänzend vergoldet



102

Blanco,Dorado brillo
Blanc,Doré brillant
White/Gold plated
Weiß/Glänzend vergoldet



106

Perla/Dorado brillo
Perle/Doré brillant
Pearl/Gold plated
Perle/Glänzend vergoldet



805

Latón cepillado rústico
Laiton brossé rustique
Rustic brushed brass
Messing rustikal, gebürstet



831

Bronce rústico
Bronze rustique
Antique brass
Bronze rustikal



836

Estaino rústico
Etain rustique
Rustic tin
Zinn rustikal



800

Bronce viejo
Vieux bronze
Old bronze
Antik bronziert



B471



B472



B473



B471



B472



B473



ZAMAK
METAL
METAL

mm mm mm mm mm mm

B471	35
B472	30
B473	25



100

Dorado brillo
Doré brillant
Gold plated
Glänzend vergoldet



102

Blanco/Dorado brillo
Blanc/Doré brillant
White/Gold plated
Weiß/Glänzend vergoldet



400

Cromo brillo
Chromé brillant
Bright chrome
Glänzend verchromt



800

Bronce viejo
Vieux bronze
Old bronze
Antik bronziert



7850 130 98 10

ZAMAK
METAL
METAL
METALL



715

Niquel satinado/Dorado brillo
Nickelê satinê/Dorê brilant
Satin nickel/Gold plated
Satiniertes Nickel/Glänzend vergoldet



717

Niquel negro/Dorado brillo
Nickelê noir/Dorê brilant
Black nickel/Gold plated
Schwarz verrickelt/Glänzend vergoldet



ZAMAK
METAL
METAL
METALL

mm4 φmm Hmm Ømm Smm

B461				35
B462				30
B463				25



100

Dorado brillo
Doré brillant
Gold plated
Glänzend vergoldet



805

Latón cepillado rústico
Laiton brossé rustique
Rustic brushed brass
Messing rustikal, gebürstet



900

Bronce viejo
Vieux bronze
Old bronze
Antik bronziert



038

Níquel cepillado
Nickel brossé
Brushed nickel
Gebürstetes Nickel



100

Dorado brillo
Doré brillant
Gold plated
Glänzend vergoldet



ZAMAK
METAL
METAL
METALL

mm4 φmm Hmm Ømm Smm

B661				35
B662				28

NEWRUSTIC

COLLECTION



8871 8872

	ZAMAK	METAL	METAL	METAL	METAL
	mm	mm	mm	mm	mm
8871				30	
8872				25	



805

Latón cepillado rústico
Laiton brossé rustique
Rustic brushed brass
Messing rustikal, gebürstet



807

Hierro rústico
Fer rustique
Rustic iron
Eisen rustikal



808

Cobre rústico
Cuivre rustique
Rustic copper
Kupfer rustikal



809

Níquel negro cepillado rústico
Nickelé noir brossé rustique
Black nickel rustic brushed
Nickel schwarz rustikal, gebürstet



831

Bronce rústico
Bronze rustique
Antique brass
Bronze rustikal



836

Estaño rústico
Etain rustique
Rustic tin
Zinn rustikal



NEWRUSTIC
COLLECTION



ZAMAK
METAL
METAL
METALL

	120	96	14
7421	120	96	14
7422	81	64	11



805

Latón cepillado rústico
Laiton brossé rustique
Rustic brushed brass
Messing rustikal, gebürstet



807

Hierro rústico
Fer rustique
Rustic iron
Eisen rustikal



808

Cobre rústico
Cuivre rustique
Rustic copper
Kupfer rustikal



809

Níquel negro cepillado rústico
Nickel noir brossé rustique
Black nickel rustic brushed
Nickel schwarz rustikal, gebürstet



831

Bronce rústico
Bronze rustique
Antique brass
Bronze rustikal



836

Estaño rústico
Étain rustique
Rustic tin
Zinn rustikal

METAL / METAL / METAL / METALL



8841

8842

7371

7372



NEWRUSTIC

COLLECTION



ZAMAK
METAL
METAL
METALL

▶mm◀ ◊mm◊ ▶|◊mm ◊mm ◊mm

7371	178	128	22	
7372	137	96	20	
8841			34	
8842			28	



038

Niquel cepillado
Nickelè brossé
Brushed nickel
Gebürstetes Nickel



808

Cobre rústico
Cuivre rustique
Rustic copper
Kupfer rustikal



809

Niquel negro cepillado rústico
Nickelè noir brossé rustique
Black nickel rustic brushed
Nickel schwarz rustikal, gebürstet



831

Bronce rústico
Bronze rustique
Antique brass
Bronze rustikal



836

Estanho rústico
Etain rustique
Rustic tin
Zinn rustikal

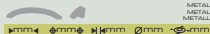

	mm	mm	mm	mm	mm
7170	150	128	18		
8770					40x18

ZAMAK
METAL
METAL
METAL



021
Aluminio
Aluminium
Aluminium



038
Niquel cepillado
Nickelé brossé
Brushed nickel
Gebürstetes Nickel



100
Dorado brillo
Doré brillant
Gold plated
Glänzend vergoldet



400
Cromo brillo
Chromé brillant
Bright chrome
Glänzend verchromt



825
Estatío cepillado
Etain brossé
Brushed tin
Zinn gebürstet



831
Bronce rústico
Bronze rustique
Antique brass
Bronze rustikal



800
Bronce viejo
Vieux bronze
Old bronze
Antik bronziert

COUNTRY COLLECTION



ROPE



ZAMAK
METAL
METALL

	100	500	810	831	836
7581	150	128	15		30
7582	114	96	13		27
8581				34	23



100
Dorado brillo
Doré brillant
Gold plated
Glänzend vergoldet



500
Niquel satinado
Nickel satiné
Satin nickel
Satiniertes Nickel



810
Negro petróleo
Noir pétrole
Oil rubbed bronze
Ölgeschwartzte Bronze



825
Etain cepillado
Etain brossé
Brushed tin
Zinn gebürstet



831
Bronce rústico
Bronze rustique
Antique brass
Bronze rustikal



836
Etain rústico
Etain rustique
Rustic tin
Zinn rustikal



COUNTRY COLLECTION

SPIRAL



mm mm mm mm mm

7561	172	128	15	28	
7562	130	96	13	28	
8561				25	32x21
8562				22	28x18



100
Dorado brillo
Doré brillant
Gold plated
Glänzend vergoldet



500
Níquel satinado
Nickel satiné
Satin nickel
Satinierter Nickel



810
Negro petróleo
Noir pétrole
Oil rubbed bronze
Ölgeschwärzte Bronze



825
Estatío cepillado
Etain brossé
Brushed tin
Zinn gebürstet



831
Bronce rústico
Bronze rustique
Antique brass
Bronze rustikal



836
Estatío rústico
Etain rustique
Rustic tin
Zinn rustikal

ZAMAK
METAL
METAL
METALL



METAL / METAL / METAL / METALL

COUNTRY COLLECTION



	40mm	45mm	50mm	60mm	65mm
7191	161	128			
7192	136	96			

ZAMAK
METAL
METAL
METALL



100

Dorado brillo
Doré brillant
Gold plated
Glänzend vergoldet



500

Niquel satinado
Nickel satiné
Satin nickel
Satiniertes Nickel



810

Negro petróleo
Noir pétrole
Oil rubbed bronze
Ölgeschwärzte Bronze



825

Estaino cepillado
Etain brossé
Brushed tin
Zinn gebürstet



831

Bronce rústico
Bronze rustique
Antique brass
Bronze rustikal



836

Estaino rústico
Etain rustique
Rustic tin
Zinn rustikal





COUNTRY

COLLECTION

CHESS



34mm x 34mm x 11mm / 1.34" x 1.34" x 0.43" (32-34mm)

B191

34x34

B192

29x29

ZAMAK
METAL
METAL
METALL



100

Dorado brillo
Doré brillant
Gold plated
Glänzend vergoldet



500

Níquel satinado
Nickel satiné
Satin nickel
Satinierter Nickel



810

Negro petróleo
Noir pétrole
Oil rubbed bronze
Ölgeschwärtzte Bronze



825

Estaino cepillado
Etain brossé
Brushed tin
Zinn gebürstet



831

Bronce rústico
Bronze rustique
Antique brass
Bronze rustikal



836

Estaino rústico
Etain rustique
Rustic tin
Zinn rustikal

METAL / METAL / METAL / METALL

COUNTRY

COLLECTION



8491



ZAMAK
METAL
METAL
METALL

Ø100x44mm x 120mm 20mm 150mm

8491

35x30



100
Dorado brillo
Doré brillant
Gold plated
Glänzend vergoldet



500
Niquel satinado
Nickelé satiné
Satin nickel
Satiniertes Nickel



810
Negro petróleo
Noir pétrole
Oil rubbed bronze
Ölgeschwärzte Bronze



825
Estatío cepillado
Etain brossé
Brushed tin
Zinn gebürstet



831
Bronce rústico
Bronze rustique
Antique brass
Bronze rustikal



836
Estatío rústico
Etain rustique
Rustic tin
Zinn rustikal



7491
7492

COUNTRY

COLLECTION

REED



16mm 6mm 13mm 2mm 25mm

	163	128
7491		
7492	128	96

ZAMAK
METAL
METAL
METAL



100
Dorado brillo
Doré brillant
Gold plated
Glänzend vergoldet



500
Níquel satinado
Nickel satiné
Satin nickel
Satiniertes Nickel



810
Negro petróleo
Noir pétrole
Oil rubbed bronze
Ölgeschwartzte Bronze



825
Etain cepillado
Etain brossé
Brushed tin
Zinn gebürstet



831
Bronce rústico
Bronze rustique
Antique brass
Bronze rustikal



836
Etain rústico
Etain rustique
Rustic tin
Zinn rustikal

INDICE / INDEX

Pag. / Ref. / Materie prima - Matière Première - Raw Material - Rohmaterial

76 7000	Acero Inoxidable-Zamak / Acier	77 7019	Acero Inoxidable / Acier Inox /	78 7923	Acero Inoxidable / Acier Inox /
	Inox-Metal / Stainless Steel-Metal /		Stainless Steel / Rostfreier Stahl		Stainless Steel / Rostfreier Stahl
	Rostfreier Stahl-Metall	74 7501	Acero Inoxidable / Acier Inox /	75 7950	Acero Inoxidable-Zamak / Acier
76 7001	Acero Inoxidable-Zamak / Acier		Stainless Steel / Rostfreier Stahl		Inox-Metal / Stainless Steel-Metal/
	Inox-Metal / Stainless Steel-Metal /	74 7502	Acero Inoxidable / Acier Inox /		Rostfreier Stahl-Metall
	Rostfreier Stahl-Metall		Stainless Steel / Rostfreier Stahl	75 7951	Acero Inoxidable-Zamak / Acier
76 7002	Acero Inoxidable-Zamak / Acier	74 7503	Acero Inoxidable / Acier Inox /		Inox-Metal / Stainless Steel-Metal/
	Inox-Metal / Stainless Steel-Metal /		Stainless Steel / Rostfreier Stahl		Rostfreier Stahl-Metall
	Rostfreier Stahl-Metall	74 7504	Acero Inoxidable / Acier Inox /	75 7952	Acero Inoxidable-Zamak / Acier
76 7003	Acero Inoxidable-Zamak / Acier		Stainless Steel / Rostfreier Stahl		Inox-Metal / Stainless Steel-Metal/
	Inox-Metal / Stainless Steel-Metal /	74 7505	Acero Inoxidable / Acier Inox /		Rostfreier Stahl-Metall
	Rostfreier Stahl-Metall		Stainless Steel / Rostfreier Stahl	75 7953	Acero Inoxidable-Zamak / Acier
76 7004	Acero Inoxidable-Zamak / Acier	74 7506	Acero Inoxidable / Acier Inox /		Inox-Metal / Stainless Steel-Metal/
	Inox-Metal / Stainless Steel-Metal /		Stainless Steel / Rostfreier Stahl		Rostfreier Stahl-Metall
	Rostfreier Stahl-Metall	80 7610	Acero Inoxidable / Acier Inox /	75 7954	Acero Inoxidable-Zamak / Acier
76 7005	Acero Inoxidable-Zamak / Acier		Stainless Steel / Rostfreier Stahl		Inox-Metal / Stainless Steel-Metal/
	Inox-Metal / Stainless Steel-Metal /	80 7611	Acero Inoxidable / Acier Inox /		Rostfreier Stahl-Metall
	Rostfreier Stahl-Metall		Stainless Steel / Rostfreier Stahl	79 7971	Acero Inoxidable-Zamak / Acier
76 7006	Acero Inoxidable-Zamak / Acier	80 7612	Acero Inoxidable / Acier Inox /		Inox-Metal / Stainless Steel-Metal/
	Inox-Metal / Stainless Steel-Metal /		Stainless Steel / Rostfreier Stahl		Rostfreier Stahl-Metall
	Rostfreier Stahl-Metall	80 7613	Acero Inoxidable / Acier Inox /	79 7972	Acero Inoxidable-Zamak / Acier
76 7007	Acero Inoxidable-Zamak / Acier		Stainless Steel / Rostfreier Stahl		Inox-Metal / Stainless Steel-Metal/
	Inox-Metal / Stainless Steel-Metal /	80 7614	Acero Inoxidable / Acier Inox /		Rostfreier Stahl-Metall
	Rostfreier Stahl-Metall		Stainless Steel / Rostfreier Stahl	81 8361	Acero Inoxidable / Acier Inox /
76 7008	Acero Inoxidable-Zamak / Acier	80 7810	Acero Inoxidable / Acier Inox /		Stainless Steel / Rostfreier Stahl
	Inox-Metal / Stainless Steel-Metal /		Stainless Steel / Rostfreier Stahl	81 8362	Acero Inoxidable / Acier Inox /
	Rostfreier Stahl-Metall	80 7811	Acero Inoxidable / Acier Inox /		Stainless Steel / Rostfreier Stahl
76 7009	Acero Inoxidable-Zamak / Acier		Stainless Steel / Rostfreier Stahl	81 8363	Acero Inoxidable / Acier Inox /
	Inox-Metal / Stainless Steel-Metal /	80 7812	Acero Inoxidable / Acier Inox /		Stainless Steel / Rostfreier Stahl
	Rostfreier Stahl-Metall		Stainless Steel / Rostfreier Stahl	78 8921	Acero Inoxidable / Acier Inox /
77 7010	Acero Inoxidable / Acier Inox /	80 7813	Acero Inoxidable / Acier Inox /		Stainless Steel / Rostfreier Stahl
	Stainless Steel / Rostfreier Stahl		Stainless Steel / Rostfreier Stahl	78 8922	Acero Inoxidable / Acier Inox /
77 7011	Acero Inoxidable / Acier Inox /	80 7814	Acero Inoxidable / Acier Inox /		Stainless Steel / Rostfreier Stahl
	Stainless Steel / Rostfreier Stahl		Stainless Steel / Rostfreier Stahl		
77 7012	Acero Inoxidable / Acier Inox /	81 7861	Acero Inoxidable / Acier Inox /		
	Stainless Steel / Rostfreier Stahl		Stainless Steel / Rostfreier Stahl		
77 7013	Acero Inoxidable / Acier Inox /	81 7862	Acero Inoxidable / Acier Inox /		
	Stainless Steel / Rostfreier Stahl		Stainless Steel / Rostfreier Stahl		
77 7014	Acero Inoxidable / Acier Inox /	79 7891	Acero Inoxidable-Zamak / Acier		
	Stainless Steel / Rostfreier Stahl		Inox-Metal / Stainless Steel-Metal/		
77 7015	Acero Inoxidable / Acier Inox /		Rostfreier Stahl-Metall		
	Stainless Steel / Rostfreier Stahl	79 7892	Acero Inoxidable-Zamak / Acier		
77 7016	Acero Inoxidable / Acier Inox /		Inox-Metal / Stainless Steel-Metal/		
	Stainless Steel / Rostfreier Stahl		Rostfreier Stahl-Metall		
77 7017	Acero Inoxidable / Acier Inox /	78 7921	Acero Inoxidable / Acier Inox /		
	Stainless Steel / Rostfreier Stahl		Stainless Steel / Rostfreier Stahl		
77 7018	Acero Inoxidable / Acier Inox /	78 7922	Acero Inoxidable / Acier Inox /		
	Stainless Steel / Rostfreier Stahl		Stainless Steel / Rostfreier Stahl		

ESTAMP

STAINLESS STEEL / ROSTFREIER STAHL



ACERO INOXIDABLE / ACIER INOX



ARTTECH
COLLECTION



7501
7502
7503
7504
7505
7506

UNIX



ACERO INOXIDABLE
ACIER INOX
STAINLESS STEEL
ROSTFREIER STAHL

mm L mm Ø mm H mm Ø mm 1/2 mm

7501	333	320	25	38
7502	301	288	25	38
7503	269	256	25	38
7504	237	224	25	38
7505	205	192	25	38
7506	173	160	25	38

031

Inoxidable cepillado
Inox brossé
Brushed stainless
Rostfreier Stahl, gebürstet



7950
7951
7952
7953
7954



ACERO INOXIDABLE-ZAMAK
ACIER INOX-METAL
STAINLESS STEEL-METAL
ROSTFREIER STAHL-METALL

mm mm mm mm mm

7950	470	448	12
7951	342	320	12
7952	246	224	12
7953	182	160	12
7954	150	128	12



431

Inoxidable cepillado/Cromo brillo
Inox brossé/Chromé brillant
Brushed stainless/Bright chrome
Rostfreier Stahl, gebürstet/Glänzend verchromt



ACERO INOXIDABLE / ACIER INOX
STAINLESS STEEL / ROSTFREIER STAHL



7000
7001
7002

7003
7004
7005
7006
7007
7008
7009



ACEPO INOXIDABLE-ZAMAK
ACIER INOX-METAL
STAINLESS STEEL-METAL
ROSTFREIER STAHL-METALL

mmmm **φmmφ** **Hmm** **Ømm** **~mm**

7000	1310	1280	14
7001	926	896	14
7002	702	672	14
7003	478	448	14
7004	414	384	14
7005	318	288	14
7006	254	224	14
7007	222	192	14
7008	190	160	14
7009	158	128	14



031
Inoxidable cepillado
Inox brossé
Brushed stainless
Rostfreier Stahl, gebürstet



7010
7011
7012

7013
7014
7015
7016
7017
7018
7019



ACERO INOXIDABLE
ACIER INOX
STAINLESS STEEL
ROSTFREIER STAHL

mmmm ϕ mmmm Hmmmm \varnothing mmmm \ominus mmmm

7010	1330	1280	12
7011	946	896	12
7012	722	672	12
7013	498	448	12
7014	434	384	12
7015	338	288	12
7016	274	224	12
7017	242	192	12
7018	210	160	12
7019	178	128	12



031
Inoxidable cepillado
Inox brossé
Brushed stainless
Rostfreier Stahl, gebürstet

ACERO INOXIDABLE / ACIER INOX
STAINLESS STEEL / ROSTFREIER STAHL



ACERO INOXIDABLE
ACIER INOX
STAINLESS STEEL
ROSTFREI STAHL

mm ϕ mm \times mm ϕ mm ϕ mm

7921	200	160	10	
7922	166	126	10	
7923	132	96	10	
8921			18	
8922			13	



031
Inoxidable cepillado
Inox brossé
Brushed stainless
Rostfreier Stahl, gebürstet



7891



7892



7871



7872



ACERO INOXIDABLE-ZAMAK
ACIER INOX-METAL
STAINLESS STEEL-METAL
ROSTFREIER STAHL-METALL

mm4 φmm4 Hmm Ømm ~mm

7891	152	128	10
7892	120	96	10



ACERO INOXIDABLE-ZAMAK
ACIER INOX-METAL
STAINLESS STEEL-METAL
ROSTFREIER STAHL-METALL

mm4 φmm4 Hmm Ømm ~mm

7871	139	128	10
7872	107	96	10



131

Inoxidable cepillado/Negro/Dorado brillo
Inox brossé/Noir/Doré brillant
Brushed stainless/Black/Gold plated
Rostfreier Stahl, gebürstet/Schwarz/Glänzend vergoldet



431

Inoxidable cepillado/Negro/Cromo brillo
Inox brossé/Noir/Chromé brillant
Brushed stainless/Black/Bright chrome
Rostfreier Stahl, gebürstet/Schwarz/Glänzend verchromt



431

Inoxidable cepillado/Cromo brillo
Inox brossé/Chromé brillant
Brushed stainless/Bright chrome
Rostfreier Stahl, gebürstet/Glänzend verchromt



7810
7811
7812
7813
7814
7810
7811
7812
7813
7814



ACERO INOXIDABLE
ACIER INOX
STAINLESS STEEL
ROSTFREIER STAHL

	mm	mm	mm	mm	mm
7810	298	288	10	26	
7811	202	192	10	25,5	
7812	170	160	10	25,5	
7813	138	128	10	25,5	
7814	106	96	10	25	
7810	200	192	8	21	
7811	168	160	8	21	
7812	136	128	8	21	
7813	104	96	8	21	
7814	72	64	8	21	



031
Inoxidable cepillado
Inox brossé
Brushed stainless
Rostfreier Stahl, gebürstet



037
Inoxidable pulido
Inox poli brillant
Polished stainless
Rostfreier Stahl, hochglanz



ACERO INOXIDABLE
ACIER INOX
STAINLESS STEEL
ROSTFREIER STAHL

mm ϕ mm \times mm \varnothing mm \times mm

8361		30
8362		25
8363		20

ACERO INOXIDABLE
ACIER INOX
STAINLESS STEEL
ROSTFREIER STAHL



mm \times mm \times mm \varnothing mm \times mm

7861	145	128	10
7862	110	98	10



031

Inoxidable cepillado
Inox brossé
Brushed stainless
Rostfreier Stahl, gebürstet



037

Inoxidable pulido
Inox poli brillant
Polished stainless
Rostfreier Stahl, hochglanz



031

Inoxidable cepillado
Inox brossé
Brushed stainless
Rostfreier Stahl, gebürstet

INDICE / INDEX

Pag. / Ref. / Materia prima - Matière Première - Raw Material - Rohmaterial

89	5001	Poli Dur / Poli Dur /	84	5911	Nylon / Nylon / Nylon / Nylon	84	5942	Nylon / Nylon / Nylon / Nylon
		Poli Dur / Poli Dur	84	5912	Nylon / Nylon / Nylon / Nylon	84	5943	Nylon / Nylon / Nylon / Nylon
89	5002	Poli Dur / Poli Dur /	84	5913	Nylon / Nylon / Nylon / Nylon	84	5944	Nylon / Nylon / Nylon / Nylon
		Poli Dur / Poli Dur	84	5914	Nylon / Nylon / Nylon / Nylon	86	5949	Nylon / Nylon / Nylon / Nylon
88	5101	Poli Dur-Zamak / Poli Dur-Metal /	86	5919	Nylon / Nylon / Nylon / Nylon	84	5951	Nylon / Nylon / Nylon / Nylon
		Poli Dur-Metal / Poli Dur-Metal	85	5921	Nylon / Nylon / Nylon / Nylon	84	5952	Nylon / Nylon / Nylon / Nylon
88	5102	Poli Dur-Zamak / Poli Dur-Metal /	85	5922	Nylon / Nylon / Nylon / Nylon	84	5953	Nylon / Nylon / Nylon / Nylon
		Poli Dur-Metal / Poli Dur-Metal	85	5923	Nylon / Nylon / Nylon / Nylon	84	5954	Nylon / Nylon / Nylon / Nylon
89	5201	Poli Dur-Zamak / Poli Dur-Metal /	85	5924	Nylon / Nylon / Nylon / Nylon	86	5959	Nylon / Nylon / Nylon / Nylon
		Poli Dur-Metal / Poli Dur-Metal	86	5929	Nylon / Nylon / Nylon / Nylon	85	5961	Nylon / Nylon / Nylon / Nylon
89	5202	Poli Dur-Zamak / Poli Dur-Metal /	85	5931	Nylon / Nylon / Nylon / Nylon	85	5962	Nylon / Nylon / Nylon / Nylon
		Poli Dur-Metal / Poli Dur-Metal	85	5932	Nylon / Nylon / Nylon / Nylon			
89	5221	Poli Dur / Poli Dur /	85	5933	Nylon / Nylon / Nylon / Nylon			
		Poli Dur / Poli Dur	85	5934	Nylon / Nylon / Nylon / Nylon			
89	5222	Poli Dur / Poli Dur /	86	5939	Nylon / Nylon / Nylon / Nylon			
		Poli Dur / Poli Dur	84	5941	Nylon / Nylon / Nylon / Nylon			

RESINS / HARZE



RESINAS / RÉSINES

ESTAMP



KIDLINE
COLLECTION



KIDLINE
COLLECTION



5953



5954



5952



5951



5944



5943



5942



5941



5914



5913



5911



5912

NYLON
NYLON
NYLON
NYLON

Κομμάκι Φορμάκι Ήλεκτρον Όργανο \varnothingmm

5911	36
5912	36
5913	36
5914	36
5941	36
5942	36
5943	36
5944	36
5951	36
5952	36
5953	36
5954	36

- 004 Verde/Vert Green/Grün
- 019 Amarillo/Jaune Yellow/Gelb
- 005 Azul/Bleu Blue/Blau





KIDLINE
COLLECTION



	Πλάτος	Ύψος	Βάρος	Διάμετρο	Ακτίνα
5921				36	
5922				36	
5923				36	
5924				36	
5931				40	
5932				36	
5933				36	
5934				36	
5961				34	
5962				25	

- NVLGN
NVLGN
NVLGN
NVLGN
- 028
Rosa/Rose
Pink/Rosa
 - 008
Rojo/Rouge
Red/Rot
 - 004
Cuero verde
Cuir vert
Green leather
Grünes Leder
 - 036
Cuero marrón
Cuir marron
Brown leather
Braunes Leder



NYLON
NYLON
NYLON
NYLON

	L: mm	φ: mm	H: mm	Ø: mm	S: mm
5919					450x70
5929					450x70
5939					450x70
5949					450x70
5959					450x70

En blister packs con elementos de fijación incluidos.

Dans des blisters, tous les éléments de fixation inclus.

In blisters, all fitting elements included.

In Blisterverpackung, Befestigungselemente eingeschlossen.



KIDLINÉ
COLLECTION

- 004
Verde/Vert
Green/Grün
- 019
Amarillo/Jaune
Yellow/Gelb
- 005
Azul/Blau
Blue/Blau
- 028
Rosa/Rose
Pink/Rosa
- 008
Rojo/Rouge
Red/Rot





5101



5102



PCU DUR-ZAMAK
PCU DUR-METAL
PCU OLF-METAL
PCU DUR-METALL

mm ϕ mm \times mm ϕ mm \times mm

5101	34
5102	28



102

Blanco/Dorado brillo
Blanc/Doré brillant
White/Gold plated
Weiß/Glänzend vergoldet



133

Negro brillo/Dorado brillo
Noir brillant/Doré brillant
Bright black/Gold plated
Glänzend schwarz/Glänzend vergoldet

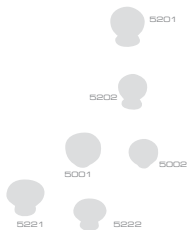

	Ømm4	Ømmφ	H mm	Ømm	Ømm
5001				34	
5002				28	
5221				37	
5222				32	

POLY DUR
POLY DUR
POLY DUR
POLY DUR



	Ømm4	Ømmφ	H mm	Ømm	Ømm
5201				34	
5202				28	

POLY DUR-ZAMAK
POLY DUR-METAL
POLY DUR-METAL
POLY DUR-METAL



002
Blanco
Blanc
White
Weiß



033
Negro brillo
Nor brillant
Bright black
Glänzend schwarz



002
Blanco
Blanc
White
Weiß



033
Negro brillo
Nor brillant
Bright black
Glänzend schwarz

INDICE / INDEX

Pag. / Ref. / Materia prima - Matière Première - Raw Material - Rohmaterial

96	9012	Madera-Zamak / Bois-Metal / Wood-Metal / Holz-Metall	98	9083	Madera-Zamak / Bois-Metal / Wood-Metal / Holz-Metall	94	9361	Madera-Zamak / Bois-Metal / Wood-Metal / Holz-Metall
96	9013	Madera-Zamak / Bois-Metal / Wood-Metal / Holz-Metall	93	9090	Madera-Zamak / Bois-Metal / Wood-Metal / Holz-Metall	94	9362	Madera-Zamak / Bois-Metal / Wood-Metal / Holz-Metall
98	9042	Madera-Zamak / Bois-Metal / Wood-Metal / Holz-Metall	97	9200	Madera-Zamak / Bois-Metal / Wood-Metal / Holz-Metall	93	9381	Madera-Zamak / Bois-Metal / Wood-Metal / Holz-Metall
98	9043	Madera-Zamak / Bois-Metal / Wood-Metal / Holz-Metall	96	9341	Madera-Zamak / Bois-Metal / Wood-Metal / Holz-Metall	93	9382	Madera-Zamak / Bois-Metal / Wood-Metal / Holz-Metall
99	9062	Madera / Bois / Wood / Holz	96	9342	Madera-Zamak / Bois-Metal / Wood-Metal / Holz-Metall	93	9383	Madera-Zamak / Bois-Metal / Wood-Metal / Holz-Metall
94	9070	Madera-Zamak / Bois-Metal / Wood-Metal / Holz-Metall	95	9351	Madera-Zamak / Bois-Metal / Wood-Metal / Holz-Metall			
98	9082	Madera-Zamak / Bois-Metal / Wood-Metal / Holz-Metall	95	9352	Madera-Zamak / Bois-Metal / Wood-Metal / Holz-Metall			

ESTAMP



MADERA / BOIS

WOOD / HOLZ

ARTTECH
COLLECTION

ARTTECH
COLLECTION



8381

8382

8383

8090



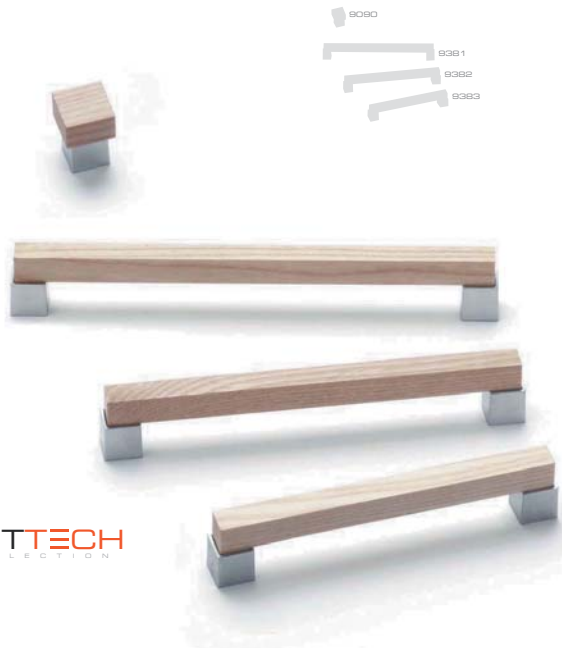

ARTTECH

COLLECTION

SYMBIOSIS

	mm	mm	mm	mm	mm
8090	21x21			29	
9381	208	192	12	29	
9382	176	160	12	29	
9383	144	128	12	29	

MADERA-ZAMAK
BOIS-MÉTAL
WOOD-METAL
HOLZ-METALL



Cromo mate/Fresno, barniz wengue
Chromé mat/Frêne, vernis wengue
Dull chrome/Ash tree, wengue varnish
Mait verchromt/Esche, Wengé lackiert



Cromo mate/Haya, barniz transparente
Chromé mat/Hêtre, vernis transparent
Dull chrome/Beech, transparent varnish
Chrom mat/Buche, transparentlackiert

MADERA / BOIS / WOOD / HOLZ



MADERA-ZAMAK
 BOIS-MÉTAL
 WOOD-METAL
 HOLZ-METALL

W mm H mm L mm Ø mm S mm

9070			30
9361	160	128	14
9362	122	96	12



022

Arce, barniz transparente/Aluminio
 Érable, vernis transparent/Aluminium
 Maple, transparent varnish/Aluminium
 Ahorn, transparentlackiert/Aluminium



315

Haya, barniz transparente/Níquel cepillado
 Hêtre, vernis transparent/Nickelé brossé
 Beech, transparent varnish/Brushed nickel
 Buche, transparentlackiert/Gebürstetes Nickel



9351



9352



MADERA-ZAMAK
BOIS-MÉTAL
WOOD-METAL
HOLZ-METALL

■ mm ◀ ◊ mm ◊ H mm Ø mm ◀ ◊ mm

9351	143	128	17
9352	110	96	15



115

Haya, barniz transparente/Dorado brillo
Hêtre, vernis transparent/Doré brillant
Beech, transparent varnish/Gold plated
Buche, transparentlackiert/Glänzend vergoldet



315

Haya, barniz transparente/Níquel cepillado
Hêtre, vernis transparent/Nickelé brossé
Beech, transparent varnish/Brushed nickel
Buche, transparentlackiert/Gebürstetes Nickel



335

Roble, barniz transparente/Níquel cepillado
Chêne, vernis transparent/Nickelé brossé
Oak, transparent varnish/Brushed nickel
Eiche, transparentlackiert/Gebürstetes Nickel



MADERA / BOIS / WOOD / HOLZ



	MADERA-ZAMAK BICH-METAL WOOD-METAL HOLZ-METALL				
	mm	mm	mm	mm	mm
8341	139	128		14	
8342	107	98		12	

	MADERA-ZAMAK BICH-METAL WOOD-METAL HOLZ-METALL				
	mm	mm	mm	mm	mm
9012				40	
9013				30	



023

Haya, barniz transparente/Aluminio
Hêtre, vernis transparent/Aluminium
Beech, transparent varnish/Aluminium
Buche, transparentlackiert/Aluminium



115

Haya, barniz transparente/Dorado brillo
Hêtre, vernis transparent/Doré brillant
Beech, transparent varnish/Gold plated
Buche, transparentlackiert/Glänzend vergoldet



115

Haya, barniz transparente/Dorado brillo
Hêtre, vernis transparent/Doré brillant
Beech, transparent varnish/Gold plated
Buche, transparentlackiert/Glänzend vergoldet



116

Haya, barniz nogal/Dorado brillo
Hêtre, vernis noyer/Doré brillant
Beech, walnut varnish/Gold plated
Buche, Nußbaum lackiert/Glänzend vergoldet



116

Haya, barniz nogal/Dorado brillo
Hêtre, vernis noyer/Doré brillant
Beech, walnut varnish/Gold plated
Buche, Nußbaum lackiert/Glänzend vergoldet



MADERA-ZAMAK BOIS-MÉTAL WOOD-METAL HOLZ-METALL				
8200	125	102	14	14



115

Haya, barniz transparente/Dorado brillo
Hêtre, vernis transparent/Doré brillant
Beech, transparent varnish/Gold plated
Buche, transparentlackiert/Glänzend vergoldet



118

Haya, barniz nogal/Dorado brillo
Hêtre, vernis noyer/Doré brillant
Beech, walnut varnish/Gold plated
Buche, Nußbaum lackiert/Glänzend vergoldet



815

Haya, barniz transparente/Bronce viejo
Hêtre, vernis transparent/Vieux bronze
Beech, transparent varnish/Old bronze
Buche, transparentlackiert/Antik bronziert



818

Haya, barniz nogal/Bronce viejo
Hêtre, vernis noyer/Vieux bronze
Beech, walnut varnish/Old bronze
Buche, Nußbaum lackiert/Antik bronziert





VADERA-ZAMAK
 BOSH-METAL
 WOOD-METAL
 HOLZ-METALL

11mm 4 4mm 4mm 5mm

9042	40
9043	30
9082	40
9083	30



915

Haya, barniz transparente/Bronce viejo
 Hêtre, vernis transparent/Vieux bronze
 Beech, transparent varnish/Old bronze
 Buche, transparentlackiert/Antik bronziert



916

Haya, barniz nogal/Bronce viejo
 Hêtre, vernis noyer/Vieux bronze
 Beech, walnut varnish/Old bronze
 Buche, Nußbaum lackiert/Antik bronziert



MADERA
BOIS
WOOD
HOLZ

mm mm mm mm mm

9062	40
9063	30



014

Haya, sn barniz
Hêtre, non verni
Beech, unvarnished
Buche, unlackiert



015

Haya, barniz transparente
Hêtre, vernis transparent
Beech, transparent varnish
Buche, transparentlackiert



016

Haya, barniz nogal
Hêtre, vernis noyer
Beech, walnut varnish
Buche, Nußbaum lackiert



025

Pino, barniz transparente
Pin, vernis transparent
Beech, transparent varnish
Kiefer, transparentlackiert



035

Roble, barniz transparente
Chêne, vernis transparent
Oak, transparent varnish
Eiche, transparentlackiert



MADERA / BOIS / WOOD / HOLZ

INDICE / INDEX

Pag. / Ref. / Materia prima - Matière Première - Raw Material - Rohmaterial

106 9501	Porcelana-Zamak / Porcelaine-Metal / Porcelain-Metal / Porzellan-Metall	105 9652	Porcelana / Porcelaine / Porcelain / Porzellan	102 9831	Porcelana-Zamak / Porcelaine-Metal / Porcelain-Metal / Porzellan-Metall
106 9502	Porcelana-Zamak / Porcelaine-Metal / Porcelain-Metal / Porzellan-Metall	105 9681	Porcelana / Porcelaine / Porcelain / Porzellan	102 9832	Porcelana-Zamak / Porcelaine-Metal / Porcelain-Metal / Porzellan-Metall
107 9511	Porcelana-Zamak / Porcelaine-Metal / Porcelain-Metal / Porzellan-Metall	104 9700	Porcelana-Zamak / Porcelaine-Metal / Porcelain-Metal / Porzellan-Metall	102 9841	Porcelana-Zamak / Porcelaine-Metal / Porcelain-Metal / Porzellan-Metall
107 9512	Porcelana-Zamak / Porcelaine-Metal / Porcelain-Metal / Porzellan-Metall	104 9710	Porcelana-Zamak / Porcelaine-Metal / Porcelain-Metal / Porzellan-Metall	102 9842	Porcelana-Zamak / Porcelaine-Metal / Porcelain-Metal / Porzellan-Metall
106 9531	Porcelana-Zamak / Porcelaine-Metal / Porcelain-Metal / Porzellan-Metall	103 9770	Porcelana-Zamak / Porcelaine-Metal / Porcelain-Metal / Porzellan-Metall	102 9851	Porcelana-Zamak / Porcelaine-Metal / Porcelain-Metal / Porzellan-Metall
106 9532	Porcelana-Zamak / Porcelaine-Metal / Porcelain-Metal / Porzellan-Metall	103 9771	Porcelana-Zamak / Porcelaine-Metal / Porcelain-Metal / Porzellan-Metall	102 9852	Porcelana-Zamak / Porcelaine-Metal / Porcelain-Metal / Porzellan-Metall
106 9533	Porcelana-Zamak / Porcelaine-Metal / Porcelain-Metal / Porzellan-Metall	103 9772	Porcelana-Zamak / Porcelaine-Metal / Porcelain-Metal / Porzellan-Metall		
107 9551	Porcelana-Zamak / Porcelaine-Metal / Porcelain-Metal / Porzellan-Metall	102 9821	Porcelana-Zamak / Porcelaine-Metal / Porcelain-Metal / Porzellan-Metall		
107 9552	Porcelana-Zamak / Porcelaine-Metal / Porcelain-Metal / Porzellan-Metall	102 9822	Porcelana-Zamak / Porcelaine-Metal / Porcelain-Metal / Porzellan-Metall		
105 9651	Porcelana / Porcelaine / Porcelain / Porzellan				

ESTAMP



PORCELAIN / PORZELLAN



PORCELANA / PORCELAIN



 PORCELANA-ZAMAK
 PORCELAIN-METAL
 PORCELAIN-METAL
 PORCELAIN-METAL

	mm	mm	mm	mm
9821	178	128	22	
9822	137	96	20	
9831			34	
9832			28	

 PORCELANA-ZAMAK
 PORCELAIN-METAL
 PORCELAIN-METAL
 PORCELAIN-METAL

	mm	mm	mm	mm
9841	178	128	22	
9842	137	96	20	
9851			34	
9852			28	



805

Craquelé/Latón cepillado rústico
 Craquelé/Latón brossé rustique
 Craquelé/Rustic brushed brass
 Craquelé/Messing rustikal, gebürstet



831

Craquelé/Bronce rústico
 Craquelé/Bronze rustique
 Craquelé/Antique brass
 Craquelé/Bronze rustikal



831

Marfil, decorada/Bronce rústico
 Ivoire, décorée/Bronze rustique
 Ivory, decorated/Antique brass
 Elfenbein, dekoriert/Bronze rustikal



PORCELANA-ZAMAK
 PORCELAIN-METAL
 PORCELAIN-METAL
 PORZELAN-METALL

mm4 ϕ mm ϕ Hmm ϕ mm ϕ -mm

9770	110	98	15
9771			37
9772			30



108

Marfil, decorada/Dorado brillo
 Ivoire, décorée/Doré brillant
 Ivory, decorated/Gold plated
 Elfenbein, dekoriert/Glänzend vergoldet



831

Marfil, decorada/Bronze rústico
 Ivoire, décorée/Bronze rustique
 Ivory, decorated/Antique brass
 Elfenbein, dekoriert/Bronze rustikal



836

Marfil, decorada/Estaño rústico
 Ivoire, décorée/Étain rustique
 Ivory, decorated/Rustic tin
 Elfenbein, dekoriert/Zinn rustikal



808

Marfil, decorada/Bronze viejo
 Ivoire, décorée/Vieux bronze
 Ivory, decorated/Old bronze
 Elfenbein, dekoriert/Antik bronziert



PORCELANA / PORCELAINE
 PORCELAIN / PORZELAN



PORCELANA-ZAMAK
PORCELAIN-METAL
PORCELAIN-METAL
PORZELAN-METALL

110mm 98mm 15mm 110mm 98mm 15mm

9700 110 98 15



PORCELANA-ZAMAK
PORCELAIN-METAL
PORCELAIN-METAL
PORZELAN-METALL

110mm 98mm 15mm 110mm 98mm 15mm

9710 110 98 15



102

Blanca/Dorado brillo
Blanche/Doré brillant
White/Gold plated
Weiß/Glänzend vergoldet



838

Blanca/Estaño rústico
Blanche/Etain rustique
White/Rustic tin
Weiß/Zinn rustikal



902

Blanca/Bronce viejo
Blanche/Vieux bronze
White/Old bronze
Weiß/Antik bronziert



100

Blanca, decorada/Dorado brillo
Blanche, décorée/Doré brillant
White, decorated/Gold plated
Weiß, dekoriert/Glänzend vergoldet



9651
9652
9681
9682

PORCELANA
PORCELAIN
PORCELAIN
PORZELAN

mm mm mm mm mm

9651	38
9652	32

PORCELANA
PORCELAIN
PORCELAIN
PORZELAN

mm mm mm mm mm

9681	38
9682	32

002
Blanca
Blanche
White
Weiß



057
Blanca, flor azul
Blanche, fleur bleue
White, blue flower
Weiß, blau Blume



PORCELANA / PORCELAINE
PORCELAIN / PORZELAN



mm 4 mm 4 mm 4 mm 4 mm 4 mm 4 mm 4 mm 4 mm 4 mm

9531	37
9532	30
9533	25



mm 11 mm 11 mm 11 mm 11 mm 11 mm 11 mm 11 mm 11 mm 11 mm

9501	37
9502	30



100

Blanca, decorada/Dorado brillo
Blanche, décorée/Doré brillant
White, decorated/Gold plated
Weiß, dekoriert/Glänzend vergoldet



102

Blanca/Dorado brillo
Blanche/Doré brillant
White/Gold plated
Weiß/Glänzend vergoldet



9511



9512



9551



9552



mm mm mm mm mm mm

9511 37

9512 30

PORCELANA-ZAMAK
PORCELAIN-METAL
PORCELAIN-METAL
PORZELAN-METALL



mm mm mm mm mm mm

9551 37

9552 30

PORCELANA-ZAMAK
PORCELAIN-METAL
PORCELAIN-METAL
PORZELAN-METALL



102

Blanca oro/Dorado brillo
Blanche cercle doré/Doré brillant
White, gold ring/Gold plated
Weiß, vergoldeter Ring/Glänzend vergoldet



102

Blanca/Dorado brillo
Blanche/Doré brillant
White/Gold plated
Weiß/Glänzend vergoldet



802

Blanca/Bronce viejo
Blanche/Vieux bronze
White/Old bronze
Weiß/Antik bronziert



PORCELANA / PORCELAINE
PORCELAIN / PORZELAN

INDICE / INDEX

Pag. / Ref. / Materia prima - Matière Première - Raw Material - Rohmaterial

110 9912	Cristal-Latón / Cristal-Laiton / Crystall-Brass / Kristall-Messing	111 9933	Cristal "Strass"-Latón / Cristal "Strass"-Laiton / "Strass" Crystall-Brass / "Strass"-Kristall-Messing	113 9982	Cristal-Latón / Cristal-Laiton / Crystall-Brass / Kristall-Messing
110 9913	Cristal-Latón / Cristal-Laiton / Crystall-Brass / Kristall-Messing			113 9983	Cristal-Latón / Cristal-Laiton / Crystall-Brass / Kristall-Messing
112 9922	Cristal-Latón / Cristal-Laiton / Crystall-Brass / Kristall-Messing	111 9952	Cristal "Strass"-Zamak / Cristal "Strass"-Metal / "Strass"-Kristall-Messing	110 9991	Cristal-Latón / Cristal-Laiton / Crystall-Brass / Kristall-Messing
112 9923	Cristal-Latón / Cristal-Laiton / Crystall-Brass / Kristall-Messing			110 9992	Cristal-Latón / Cristal-Laiton / Crystall-Brass / Kristall-Messing
111 9932	Cristal "Strass"-Latón / "Strass" Crystall-Brass / "Strass"-Kristall-Messing	111 9953	Cristal "Strass"-Zamak / Cristal "Strass"-Metal / "Strass" Crystall-Brass / "Strass"-Kristall-Messing	110 9993	Cristal-Latón / Cristal-Laiton / Crystall-Brass / Kristall-Messing

CRISTAL / CRISTAL



CRYSTAL / KRISTALL

ESTAMP





9991



9992



9993



9912



9913



10mm 4mm 14mm 2mm 35mm

9991 35

9992 30

9993 25



11mm 4mm 14mm 2mm 30mm

9912 30

9913 25



100

Transparente/Dorado brillo
Transparent/Doré brillant
Transparent/Gold plated
Transparent/Glänzend vergoldet



100

Transparente/Dorado brillo
Transparent/Doré brillant
Transparent/Gold plated
Transparent/Glänzend vergoldet



111

Mate/Dorado brillo
Mat/Doré brillant
Dull/Gold plated
Matt/Glänzend vergoldet



400

Transparente/Cromo brillo
Transparent/Chromé brillant
Transparent/Bright chrome
Transparent/Glänzend verchromt



9932



9933



9952



9953



CRISTAL "STRASS"-LATON
CRISTAL "STRASS"-LATON
"STRASS" CRYSTAL-BRASS
"STRASS"-KRISTALL-MESSING

h mm ϕ mm ϕ mm H mm Ø mm S mm

9932 30

9933 20



CRISTAL "STRASS"-ZAMAK
CRISTAL "STRASS"-METAL
"STRASS" CRYSTAL-METAL
"STRASS"-KRISTALL-METALL

h mm ϕ mm ϕ mm H mm Ø mm S mm

9952 30

9953 25



100

Transparente/Dorado brillo
Transparent/Doré brillant
Transparent/Gold plated
Transparent/Glänzend vergoldet



100

Transparente/Dorado brillo
Transparent/Doré brillant
Transparent/Gold plated
Transparent/Glänzend vergoldet



CRISTAL-LATON
 CRISTAL-LATON
 CRYSTAL-BRASS
 KRISTALL-NIESSING

10mm 4mm 11mm 2mm 2mm

9922	30
9923	25



100

Transparente/Dorado brillo
 Transparent/Doré brillant
 Transparent/Gold plated
 Transparent/Glänzend vergoldet



400

Transparente/Cromo brillo
 Transparent/Chromé brillant
 Transparent/Bright chrome
 Transparent/Glänzend verchromt



CRISTAL-LATON
 CRISTAL-LATON
 CRYSTAL-BRASS
 KRISTALL-MESSING

mm ϕ mm \times mm \varnothing mm \rightarrow mm

9982	30
9983	25



100

Transparente/Dorado brillo
 Transparent/Doré brillant
 Transparent/Gold plated
 Transparent/Glänzend vergoldet



400

Transparente/Cromo brillo
 Transparent/Chromé brillant
 Transparent/Bright chrome
 Transparent/Glänzend verchromt

INDICE / INDEX

Pag. / Ref. / Materia prima - Matière Première - Raw Material - Rohmaterial

127	ED-15	Hierro / Fer / Iron / Eisen	119	3262	Zamak / Metal / Metal / Metall	122	3801	Latón-Hierro / Laiton-Fer /
126	M-45	Hierro / Fer / Iron / Eisen	120	3271	Zamak / Metal / Metal / Metall			Brass-Iron / Messing-Eisen
127	T-11	Hierro / Fer / Iron / Eisen	120	3272	Zamak / Metal / Metal / Metall	122	3802	Latón-Hierro / Laiton-Fer /
127	T-14	Hierro / Fer / Iron / Eisen	117	3500	Zamak / Metal / Metal / Metall			Brass-Iron / Messing-Eisen
127	T-21	Hierro / Fer / Iron / Eisen	123	3502	Latón / Laiton / Brass / Messing	123	3810	Latón / Laiton / Brass / Messing
127	T-25	Hierro / Fer / Iron / Eisen	123	3503	Latón / Laiton / Brass / Messing	122	3900	Zamak-Plástico / Metal-
127	T-31	Hierro / Fer / Iron / Eisen	117	3510	Zamak / Metal / Metal / Metall			Plastique / Metal-Plastic /
127	T-35	Hierro / Fer / Iron / Eisen	121	3511	Zamak / Metal / Metal / Metall			Metall-Kunststoff
127	T-40	Hierro / Fer / Iron / Eisen	121	3512	Zamak / Metal / Metal / Metall	121	3921	Zamak / Metal / Metal / Metall
127	T-52	Hierro / Fer / Iron / Eisen	123	3552	Latón-Hierro / Laiton-Fer /	121	3922	Zamak / Metal / Metal / Metall
127	T-60	Hierro / Fer / Iron / Eisen			Brass-Iron / Messing-Eisen	122	3930	Zamak-Plástico / Metal-
127	231	Nylon / Nylon / Nylon / Nylon	117	3560	Zamak / Metal / Metal / Metall			Plastique / Metal-Plastic /
127	232	Nylon / Nylon / Nylon / Nylon	117	3561	Zamak / Metal / Metal / Metall			Metall-Kunststoff
124	2000	Zamak / Metal / Metal / Metall	117	3562	Zamak / Metal / Metal / Metall	118	3940	Zamak / Metal / Metal / Metall
125	2810	Zamak / Metal / Metal / Metall	117	3600	Zamak / Metal / Metal / Metall			
120	3251	Zamak / Metal / Metal / Metall	116	3701	Zamak / Metal / Metal / Metall			
120	3252	Zamak / Metal / Metal / Metall	116	3702	Zamak / Metal / Metal / Metall			
119	3261	Zamak / Metal / Metal / Metall	116	3703	Zamak / Metal / Metal / Metall			

ESTAMP

COMPLEMENTOS / COMPLEMENTS



COMPLEMENTOS / ERGÄNZUNGEN



ARTTECH
COLLECTION



ARTTECH

COLLECTION

INLAY



	mm	mm	mm	mm	mm
--	----	----	----	----	----

3701	145	50	139x40
3702	113	42	110x35
3703	83	36	78x26

- | | | | |
|---|---|---|---|
|  |  |  |  |
| 038
Niquel cepillado
Nickelè brossé
Brushed nickel
Gebürstetes Nickel | 100
Dorado brillo
Doré brillant
Gold plated
Glänzend vergoldet | 400
Cromo brillo
Chromé brillant
Bright chrome
Glänzend verchromt | 800
Cromo mate
Chromé mat
Dull chrome
Matt verchromt |

ZAMAK
METAL
METAL
METALL



3500
3510
3511
3512

3560
3561
3562

ARTTECH

COLLECTION

STYLUS



ZAMAK
METAL
METAL
METALL

mm mm mm mm mm mm

3500	65	60
3510	49	45
3511	40	35
3512	30	26



002 Blanco Blanc White Weiß	038 Niquel cepillado Nickelè brossé Brushed nickel Gebürstetes Nickel	100 Dorado brillo Doré brillant Gold plated Glänzend vergoldet
400 Cromo brillo Chromé brillant Bright chrome Glänzend verchromt	800 Cromo mate Chromé mat Dull chrome Matt verchromt	



ZAMAK
METAL
METAL
METALL

mm mm mm mm mm mm

3500	64x64	60
3560	50x50	45
3561	38x38	35
3562	28x28	26

038 Niquel cepillado Nickelè brossé Brushed nickel Gebürstetes Nickel	100 Dorado brillo Doré brillant Gold plated Glänzend vergoldet	400 Cromo brillo Chromé brillant Bright chrome Glänzend verchromt	800 Cromo mate Chromé mat Dull chrome Matt verchromt



COMPLEMENTOS / COMPLÉMENTS
COMPLÉMENTS / ERGÄNZUNGEN



3940



ZAMAK
METAL
METAL
METALL

130mm 64mm 64mm 34mm 34mm

3940 130 64 34



Q21
Aluminio
Aluminium
Aluminium
Aluminium



B07
Hierro rústico
Fer rustique
Rustic iron
Eisen rustikal



Q38
Níquel cepillado
Nickelé brossé
Brushed nickel
Gebürstetes Nickel



B36
Estaino rústico
Etain rustique
Rustic tin
Zinn rustikal



B05
Latón cepillado rústico
Laiton brossé rustique
Rustic brushed brass
Messing rustikal, gebürstet



3261



3262



mm4 φmm H/mm Ømm ~mm

3261	80	35
3262	36	36

ZAMAK
METAL
METAL
METALL



002
Blanco
White
Weiß



038
Níquel cepillado
Nickelé brossé
Brushed nickel
Gebürstetes Nickel



100
Dorado brillo
Doré brillant
Gold plated
Glänzend vergoldet



500
Níquel satinado
Nickelé satiné
Satin nickel
Sattiniertes Nickel



800
Cromo mate
Chromé mat
Dull chrome
Matt verchromt



COMPLEMENTOS / COMPLÉMENTS
COMPLEMENTES / ERGÄNZUNGEN

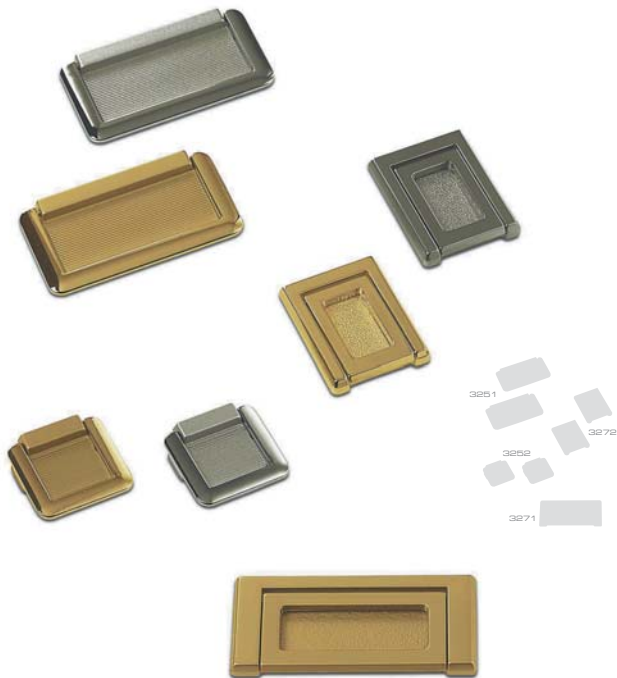

ZAMAK
METAL
METAL
METALL

	Wmm	Φmm	Hmm	Ømm	mm
3251	70	40			
3252	35	35			

ZAMAK
METAL
METAL
METALL

	Wmm	Φmm	Hmm	Ømm	mm
3271	82	38			
3272	38	50			



112

Dorado brillo/Pintado dorado
Doré brillant/Peint en doré
Gold plated/Gold painted
Glänzend vergoldet/Golden bemalt



413

Cromo brillo/Pintado plata
Chromé brillant/Peint en argenté
Bright chrome/Silver painted
Glänzend verchromt/Silber bemalt



100

Dorado brillo
Doré brillant
Gold plated
Glänzend vergoldet



200

Dorado satinado
Doré satiné
Satin gold plated
Satinisiertes Gold



500

Niquel satinado
Nickelé satiné
Satin nickel
Satinisiertes Nickel



ZAMAK
METAL
METAL
METALL

	3511	3512
	40	30



002
Blanco
Blanc
White
Weiß



038
Niquel cepillado
Nickelé brossé
Brushed nickel
Gebürstetes Nickel



100
Dorado brillo
Doré brillant
Gold plated
Glänzend vergoldet



400
Cromo brillo
Chromé brillant
Bright chrome
Glänzend verchromt



800
Cromo mate
Chromé mat
Dull chrome
Matt verchromt



ZAMAK
METAL
METAL
METALL

	3921	3922
	150	110
	40	36



002
Blanco
Blanc
White
Weiß



038
Niquel cepillado
Nickelé brossé
Brushed nickel
Gebürstetes Nickel



100
Dorado brillo
Doré brillant
Gold plated
Glänzend vergoldet



400
Cromo brillo
Chromé brillant
Bright chrome
Glänzend verchromt



800
Cromo mate
Chromé mat
Dull chrome
Matt verchromt



831
Bronce rústico
Bronze rustique
Antique brass
Bronze rustikal



COMPLEMENTOS / COMPLÉMENTS
COMPLÉMENTS / ERGÄNZUNGEN



3801
3802

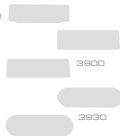

3900

3930



LATCHER
LATCHER-FER
BRASS-IRON
MESSING-EISEN

	mm	mm	mm	mm	mm
3801	115	42			
3802	80	36			



ZAMAK-PLASTIC
METAL-PLASTIC
METAL-PLASTIC
METAL-KUNSTSTOFF

	mm	mm	mm	mm	mm
3900	110	96	40		
3930	110	96	40		



103

Latón brillo/Negro
Laiton brillant/Noir
Bright brass/Black
Glänzendes Messing/Schwarz



112

Latón brillo/Pintado dorado
Laiton brillant/Peint en doré
Bright brass/Gold painted
Glänzendes Messing/Golden bemalt



112

Dorado brillo/Pintado dorado
Doré brillant/Peint en doré
Gold plated/Gold painted
Glänzend vergoldet/Golden bemalt



413

Cromo brillo/Pintado plata
Chromé brillant/Peint en argenté
Bright chrome/Silver painted
Glänzend verchromt/Silbern bemalt



403

Cromo brillo/Negro
Chromé brillant/Noir
Bright chrome/Black
Glänzend verchromt/Schwarz



413

Cromo brillo/Pintado plata
Chromé brillant/Peint en argenté
Bright chrome/Silver painted
Glänzend verchromt/Silbern bemalt



LATÓN
LAITON
BRASS
MESSING

mm 4 φmm φ mm mm Ømm -mm

3502 52x52

3503 44x44



LATÓN+IERRO
LAITON-FER
BRASS-IRON
MESSING-EISEN

mm 4 φmm φ mm mm Ømm -mm

3552 52x52



LATÓN
LAITON
BRASS
MESSING

mm 4 φmm φ mm mm Ømm -mm

3810 85 25



112

Dorado brillo y pintado dorado
Doré brillant et peint en doré
Gold plated and gold painted
Glänzend vergoldet und golden bemalt



413

Cromo brillo y pintado plata
Chromé brillant et peint en argenté
Bright chrome and silver painted
Glänzend verchromt und silbern bemalt



112

Latón brillo/Pintado dorado
Laiton brillant/Peint en doré
Bright brass/Gold painted
Glänzendes Messing/Golden bemalt



COMPLEMENTOS / COMPLÉMENTS
COMPLÉMENTS / ERGÄNZUNGEN



ZAMAK
METAL
METAL
METALL

140mm 40mm 140mm 20mm 5mm

2000 140



100

Dorado brillo
Doré brillant
Gold plated
Glänzend vergoldet



200

Dorado satinado
Doré satiné
Satin gold plated
Satiniertes gold



400

Cromo brillo
Chromé brillant
Bright chrome
Glänzend verchromt



800

Cromo mate
Chromé mat
Dull chrome
Matt verchromt



900

Bronce viejo
Vieux bronze
Old bronze
Antik bronziert

En blister packs con elementos de fijación incluidos.
Dans des blisters, tous les éléments de fixation inclus.
In blisters, all fitting elements included.

In Blisterverpackung, Befestigungselemente eingeschlossen.



ZAMAK
METAL
METAL
METALL

mm ϕ mm \times mm \varnothing mm \sim mm

2810 70x70



002
Blanco
Blanc
White
Weiß



100
Dorado brillo
Doré brillant
Gold plated
Glänzend vergoldet



400
Cromo brillo
Chromé brillant
Bright chrome
Glänzend verchromt



500
Niquel satinado
Nickel satiné
Satin nickel
Satiniertes Nickel



COMPLEMENTOS / COMPLÉMENTS
COMPLEMENTIS / ERGÄNZUNGEN

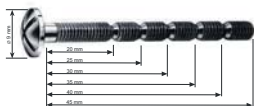

	mm	mm	mm	mm	mm
M-45	20				9
M-45	25				9
M-45	30				9
M-45	35				9
M-45	40				9
M-45	45				9

TORNILLO MULTILARGO / Hierro

M-45 Bicromatado

VIS MULTILONGUEUR / Fer

M-45 Bichromaté

MULTISIZE SCREW / Iron

M-45 Zinc-yellow

MULTILÄNGEN SCHRAUBE / Eisen

M-45 Bichromatiert

TORNILLO MULTILARGO DE CORTE LIMPIO QUE SIEMPRE ROSCA

VIS MULTILONGUEUR QUI SE COUPE FACILEMENT SANS ABÎMER LE FILETAGE

MULTISIZE SCREW NET CUT THAT ALWAYS SCREWS

MULTILÄNGENSCHRAUBE IMMER GÄNGIG DANK DEM SAUBEREN GEWINDESCHNITT



REDUZCA LA INVERSIÓN
En inmovilizado y el riesgo de restos invendibles sustituyendo los tornillos de diversas longitudes por el tornillo multilargo ESTAMP.

REDUISEZ L'INVESTISSEMENT
Des stocks immobilisés et le risque d'invendus en remplaçant les vis de différentes longueurs par une seule vis multilongueur ESTAMP.

REDUCE INVESTMENT
In stocks and risk of not saleable rests substituting screws of different lengths for multisize ESTAMP screw.

REDUZIEREN SIE IHRE INVESTITIONEN
In Anlagen und vermeiden Sie das Risiko, auf unverkäuflichen Resten sitzen zu bleiben. Verwenden Sie anstatt Schrauben verschiedener Längen die ESTAMP Multilängenschraube.



REDUZCA EL ESPACIO
De almacenaje manteniendo en stock una sola longitud de tornillo.

REDUISEZ LE VOLUME
De stockage en disposant d'une seule longueur de vis.

REDUCE SPACE
For storage keeping only one length of screw.

GERINGERER LAGERPLATZBEDARF
Dank einer einzigen Schraubenlänge.



REDUZCA EL GASTO
En mano de obra eliminando el limado de espárragos tradicionales al utilizar el tornillo multilargo ESTAMP de corte limpio y roscado directo.

REDUISEZ LES FRAIS
De main-d'oeuvre pour le limage des tiges traditionnelles en utilisant la vis ESTAMP multilongueur de coupe facile et directe vis.

REDUCE EXPENSES
On labour eliminating filing of traditional screw by using multisize ESTAMP screws of net cut and direct screw.

REDUZIEREN SIE IHRE LÖHNKOSTEN
Die sauber geschnittene, direktgängige ESTAMP Multilängenschraube macht das herkömmliche Steh-schraubenfeilen überflüssig.

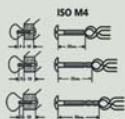

ADAPTABLE
A los groesos de madera utilizados en carpintería y ebanistería. Nuestros herrajes ESTAMP llevan incorporados este nuevo tipo de tornillo.

ADAPTABLE
À toutes les épaisseurs de bois utilisés en menuiserie et en ébénisterie. Nos articles ESTAMP portent tous ce nouveau type de vis.

ADAPTABLE
To different thicknesses of wood used in carpentry and woodwork industry. Our fittings ESTAMP are fitted with this new kind of screw.

ANPASSUNGSFÄHIG
Für alle in der Tischlerei und Schreinerei gebräuchlichen Holz-dicken geeignete. Unsere ESTAMP Möbelbeschläge werden mit diesem neuartigen Schraubentyp geliefert.



NYLON
NYLON
NYLON
NYLON

CIERRES A PRESIÓN / Nylon

231 Para puertas grandes

232 Para puertas pequeñas

FERMATURES À PRESSION / Nylon

231 Pour grandes portes

232 Pour petites portes

PRESSURE LOCKS / Nylon

231 For large doors

232 For small doors

DRUCKVERSCHLÜSSE / Nylon

231 Für grosse Türen

232 Für kleine Türen



HIERRO
FER
EISEN

11mm 11mm 11mm 11mm 11mm

T-11	11	9
T-14	14	9
T-21	21	9
T-25	25	9
T-31	31	9
T-35	35	9
T-40	40	9
T-52	52	9
T-60	60	9

TORNILLOS / Hierro

SCREWS / Iron

T Bicomatado

T Zinc-yellow

VS / Fer

SCHRAUBE / Eisen

T Bichromaté

T Bichromatiert



HIERRO
FER
EISEN

15mm 15mm 15mm 15mm 15mm

ED-15	15	
-------	----	--

ESPÁRRAGO ROSCA MADERA / Hierro

ED-15 Bicomatado

TIGES FILETÉES POUR BOIS / Fer

ED-15 Bichromaté

WOOD SCREW / Iron

ED-15 Zinc-yellow

GEWINDESCHRAUBE FÜR HOLZ / Eisen

ED-15 Bichromatiert



INDICE / INDEX

Pag. / Ref. / Materia prima - Matière Première - Raw Material - Rohmaterial

132	2840	Zamak / Metal / Metal / Metall	130	7512	Acero Inoxidable / Acier Inox / Stainless Steel / Rostfreier Stahl
132	2850	Zamak / Metal / Metal / Metall			
132	2860	Zamak / Metal / Metal / Metall	130	7513	Acero Inoxidable / Acier Inox / Stainless Steel / Rostfreier Stahl
130	7511	Acero Inoxidable / Acier Inox / Stainless Steel / Rostfreier Stahl			

ESTAMP

DECORCLASS



DECORCLASS



DECORCLASS
COMPLEMENTS

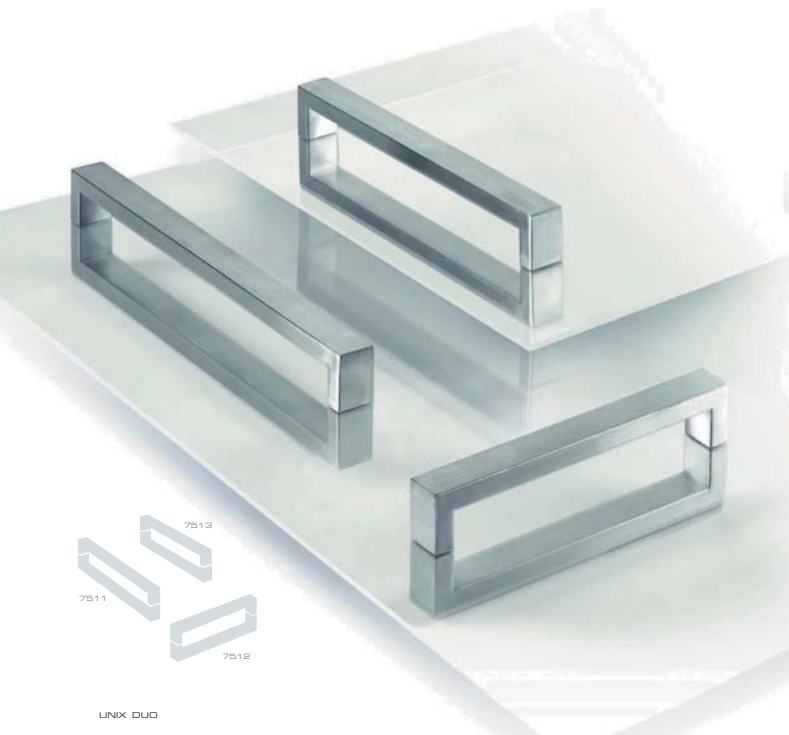

UNIX DUO



ACERO INOXIDABLE
ACIER INOX
STAINLESS STEEL
ROSTFREIER STAHL

mm mm mm mm mm

7511	333	320	25	38
7512	269	256	25	38
7513	205	192	25	38

Elementos de fijación incluidos.

Éléments de fixation inclus.

All fitting elements included.

Befestigungselemente eingeschlossen.



031

Acero inoxidable cepillado
Acier inox brossé
Brushed stainless steel
Rostfreier Stahl, gebürstet

DECORCLASS

COMPLÉMENTS

Tiradores de trazo puro, terminación impecable y gran carácter. El complemento perfecto para sus puertas de madera o cristal.

Poignées aux traits purs, finition impeccable et grand caractère. Le complément parfait pour vos portes en bois ou en cristal.

Handles with pure lines, perfect finish and strong character. The perfect complement for your wooden and crystal doors.

Griffe mit klaren Linien, tadellosem Finish und starkem Charakter. Die perfekte Ergänzung für Ihre Türen aus Glas oder Holz.





SLIDE



ZAMAK
METAL
METAL
METALL



2840	54x44
2850	55x49
2860	56x25



038

Nichel cepillado
Nickelé brossé
Brushed nickel
Gebürstetes Nickel



400

Cromo brillo
Chromé brillant
Bright chrome
Glänzend verchromt



800

Cromo mate
Chromé mat
Dull chrome
Matt verchromt



La mayor calidad al servicio del diseño más innovador.
La meilleure qualité au service du design le plus innovateur.
Best quality for the most innovative design.
Beste Qualität für das neuartigste Design.



Los colgadores individuales poseen una efectiva y fácil manera de fijación.

Les portemanteaux individuels incorporent un système de fixation simple et efficace.

Individual hangers grant an easy and effective fixing system.

Die Einzelkleiderhaken verfügen über ein einfaches und wirksames Befestigungssystem.

<u>Ref.</u>	<u>Pag.</u>	<u>Ref.</u>	<u>Pag.</u>	<u>Ref.</u>	<u>Pag.</u>	<u>Ref.</u>	<u>Pag.</u>
2000	124	5942	84	7300	34	7681	17
2810	125	5943	84	7311	35	7682	17
2840	132	5944	84	7312	35	7683	17
2850	132	5949	86	7321	37	7684	17
2860	132	5951	84	7322	37	7691	19
3251	120	5952	84	7351	33	7692	19
3252	120	5953	84	7352	33	7693	19
3261	119	5954	84	7371	64	7694	19
3262	119	5959	86	7372	64	7730	18
3271	120	5961	85	7381	29	7731	18
3272	120	5962	85	7382	29	7732	18
3500	117	7000	76	7411	32	7733	18
3502	123	7001	76	7412	32	7734	18
3503	123	7002	76	7421	63	7735	18
3510	117	7003	76	7422	63	7736	18
3511	121	7004	76	7461	28	7737	18
3512	121	7005	76	7462	28	7738	18
3552	123	7006	76	7463	28	7739	18
3560	117	7007	76	7471	27	7740	18
3561	117	7008	76	7472	27	7741	18
3562	117	7009	76	7473	27	7751	11
3580	15	7010	77	7481	26	7752	11
3581	15	7011	77	7482	26	7810	80
3582	15	7012	77	7483	26	7811	80
3583	15	7013	77	7491	71	7812	80
3600	117	7014	77	7492	71	7813	80
3701	116	7015	77	7501	74	7814	80
3702	116	7016	77	7502	74	7830	57
3703	116	7017	77	7503	74	7850	59
3710	14	7018	77	7504	74	7861	51
3720	13	7019	77	7505	74	7861	81
3730	13	7020	21	7506	74	7862	51
3740	13	7021	21	7511	130	7862	81
3801	122	7022	21	7512	130	7891	79
3802	122	7023	21	7513	130	7892	79
3810	123	7024	21	7520	21	7921	78
3900	122	7025	21	7521	21	7922	78
3921	121	7026	21	7531	10	7923	78
3922	121	7031	46	7532	10	7930	47
3930	122	7032	46	7541	24	7950	75
3940	118	7051	44	7542	24	7951	75
5001	89	7052	44	7543	24	7952	75
5002	89	7061	48	7552	50	7953	75
5101	88	7062	48	7553	50	7954	75
5102	88	7081	44	7554	50	7971	79
5201	89	7082	44	7561	67	7972	79
5202	89	7121	43	7562	67	7991	49
5221	89	7122	43	7570	12	7992	49
5222	89	7131	40	7571	12	8010	56
5911	84	7132	40	7572	12	8080	28
5912	84	7140	40	7581	66	8090	27
5913	84	7150	41	7582	66	8101	25
5914	84	7161	36	7610	80	8102	25
5919	86	7162	36	7611	80	8103	25
5921	85	7170	65	7612	80	8130	24
5922	85	7191	68	7613	80	8191	69
5923	85	7192	68	7614	80	8192	69
5924	85	7241	30	7651	20	8321	53
5929	86	7242	30	7652	20	8322	53
5931	85	7251	31	7653	20	8323	53
5932	85	7252	31	7661	23	8324	53
5933	85	7281	39	7662	23	8351	54
5934	85	7282	39	7663	23	8352	54
5939	86	7291	38	7671	16	8353	54
5941	84	7292	38	7672	16	8354	54

<u>Ref.</u>	<u>Pag.</u>	<u>Ref.</u>	<u>Pag.</u>
8361	81	9381	93
8362	81	9382	93
8363	81	9383	93
8461	61	9501	106
8462	61	9502	106
8463	61	9511	107
8471	58	9512	107
8472	58	9531	106
8473	58	9532	106
8491	70	9533	106
8561	67	9551	107
8562	67	9552	107
8581	66	9651	105
8651	60	9652	105
8652	60	9681	105
8653	60	9682	105
8661	61	9700	104
8662	61	9710	104
8671	45	9770	103
8672	45	9771	103
8673	45	9772	103
8691	48	9821	102
8692	48	9822	102
8701	42	9831	102
8702	42	9832	102
8711	42	9841	102
8712	42	9842	102
8721	49	9851	102
8722	49	9852	102
8731	43	9912	110
8732	43	9913	110
8751	60	9922	112
8752	60	9923	112
8770	65	9932	111
8780	31	9933	111
8790	56	9952	111
8800	37	9953	111
8810	55	9982	113
8820	55	9983	113
8830	52	9991	110
8841	64	9992	110
8842	64	9993	110
8851	29	ED-15	127
8852	29	M-45	126
8871	62	T-11	127
8872	62	T-14	127
8921	78	T-21	127
8922	78	T-25	127
9012	96	T-31	127
9013	96	T-35	127
9042	98	T-40	127
9043	98	T-52	127
9062	99	T-60	127
9063	99		
9070	94		
9082	98		
9083	98		
9090	93		
9200	97		
9341	96		
9342	96		
9351	95		
9352	95		
9361	94		
9362	94		